

HEADLINING- EXTERIOR DECALS AND OVERLAYS

3P

SECTION INDEX

	Page		Page
Exterior Decals	3P-2	Headlining	3P-1
Exterior Woodgrain Overlays	3P-6	Tools	3P-9

HEADLINING

	Page		Page
CJ-7 Limited	3P-1	General	3P-1
Cherokee-Wagoneer Models	3P-1	Truck Models	3P-2

GENERAL

The headlining used in CJ-7 Limited, Cherokee, Wagoneer and Truck models is made of laminated polystyrene backing board which is finished, depending on the model, with either a plastic coating, or a close knit fabric. Lines pressed into the backing board allow the headlining to be shaped to fit the contour of the roof while providing added strength for self-support.

NOTE: Information regarding the headliner used with the Wagoneer Limited power sun roof can be found in Chapter 3L.

CJ-7 LIMITED

Removal

- (1) Remove moulded top as outlined in Chapter 3L.
- (2) Remove dome lamp from top.
- (3) Remove right and left side mouldings.
- (4) Remove headlining retainer screws.
- (5) Manuever headlining out of front and rear mouldings and remove headlining.

Installation

- (1) Position headlining into front and rear mouldings.
- (2) Install retaining screws on right and left side.

- (3) Install side mouldings.
- (4) Install dome lamp assembly.
- (5) Install top on vehicle as outlined in Chapter 3L.

CHEROKEE-WAGONEER MODELS

Removal

- (1) Remove sun visors, escutcheons and center support.
- (2) Remove windshield moulding and end caps.
- (3) Remove rear opening moulding and end caps.
- (4) Remove plastic trim center moulding and end cap retainers.
- (5) Remove lens from dome lamp and cargo lamp. Remove screws attaching lamp to roof bows. Remove and disconnect cargo lamp switch.
- (6) Remove coat hooks.
- (7) If equipped with inside spare tire, proceed as follows:
 - (a) Remove inside spare tire.
 - (b) Remove upper bracket shoulder screw, using Torx Bit Tool J-25359-C.
- (8) Free rear headlining from J-moulding by pulling down carefully at center, while pushing up on either outside edge.
- (9) Push cargo lamp through die-cut opening in headlining.

(10) Remove rear headlining through tailgate opening.

(11) Free front headlining from J-moulding by pulling down carefully at center, while pushing up on outside edges.

(12) Remove front headlining through tailgate opening.

Installation

(1) Position front headlining in vehicle and insert left side into J-moulding.

(2) Pull dome lamp through die-cut opening in headlining and align front headlining to vehicle roof.

(3) Pull down carefully at center of front headlining and insert right side of headlining into J-moulding.

(4) Position rear headlining in vehicle and insert left front headlining using sun visor and dome lamp holes and leading edge of headlining as guide. Adjust fore or aft as required.

(5) Check alignment of rear headlining using trailing edge as guide. Adjust fore or aft as required.

(6) Secure dome lamp and cargo lamp to roof bows and install lamp lenses. Connect and install cargo lamp switch.

(7) Install plastic center mouldings and end cap retainers.

(8) If equipped with inside spare tire, proceed as follows:

(a) Position upper bracket on headlining and install shoulder screw, using Torx Bit Tool J-25359-C.

(b) Install spare tire.

(9) Install sun visors, escutcheons and center support.

(10) Install windshield moulding and end caps.

(11) Install rear opening moulding and end caps.

Roof Bow Adjustment

Noise from the headlining may be caused by improperly adjusted roof bows.

(1) Remove headlining.

(2) Loosen roof bow attaching screws, using Torx Bit J-25359-C.

(3) Insert screwdriver through hole in roof bow and raise roof bow against roof panel.

(4) Tighten roof bow attaching screws using Torx Bit J-25359-C.

(5) Install headliner.

TRUCK MODELS

Removal

(1) Remove sun visors and center support.

(2) Remove lens from dome lamp. Remove screws attaching dome lamp to rear window panel.

(3) Remove windshield moulding and end caps.

(4) Pull down carefully at center of headlining while pushing up on outside edges to disengage headlining from J-moulding.

(5) Push dome lamp through die-cut opening in headlining.

(6) Remove headlining from vehicle.

Installation

(1) Position headlining in vehicle and insert left side into J-mouldings.

(2) Pull dome lamp through die-cut opening and align headlining to vehicle roof.

(3) Pull down carefully at center of headlining while pushing up on right edge, and insert right side of headlining into J-moulding.

(4) Check alignment of headlining using sun visor and dome lamp holes and headlining leading edge as guides. Adjust fore and aft as necessary.

(5) Secure dome lamp to rear window panel and install dome lamp lens.

(6) Install windshield moulding and end cap.

(7) Install sun visors and center support.

EXTERIOR DECALS

	Page
General	3P-2
Repair	3P-2

	Page
Replacement	3P-2

GENERAL

Exterior decals and stripes are made of tough, durable, weather-resistant solid vinyl and have a pressure-sensitive back. The pressure-sensitive back is protected

by a paper backing which is removed at installation. The front (or face) of stripes and decals may be covered with an easy-release paper for protection at installation and during shipment or storage. The paper should be removed after installation.

REPAIRS

Small nicks or scratches can be touched up with paint in much the same manner as painted surfaces. Proper color match can be obtained by mixing small amounts of appropriate paint colors, then applying it to the affected area of the decal.

To repair blisters or air bubbles, pierce them with a sharp needle or pin. Work the trapped air out through the pin hole and press the decal firmly against the panel. It may be necessary to preheat the panel slightly, with Heat Gun J-25070, to soften the adhesive. Heat also may be used to remove small wrinkles or irregularities.

REPLACEMENT

Preparation

The temperature of the workroom should be between 65°F and 90°F. Decals should not be replaced in temperatures below 65°F.

The following equipment and materials are necessary for a quality installation:

- Woodgrain and Stripe Remover (3M, or equivalent)
- Adhesive Remover (3M, or equivalent)
- Liquid detergent (Joy, Vel, or equivalent)
- Wax and silicone remover (3M General Purpose Adhesive Cleaner, xylol, or equivalent)
- Isopropyl alcohol (rubbing alcohol)
- Squeegee (4 to 5 inches wide, plastic or hard rubber)
- Water bucket and sponge
- Sandpaper (No. 220, 360 or 400 wet or dry type)
- Heat Gun J-25070 or infrared heat bulb with extension cord
- Clean wiping rags or paper towels
- Sharp knife, single-edge razor blade or X-acto knife
- Scissors
- Sharp needle or pin
- Grease pencil

Removal

(1) Clean repair surfaces, adjacent panels and openings as required.

(2) Remove decal overlapping parts from affected panel.

(3) Mask off area surrounding panel.

(4) Scuff sand decal with 220 grade wet or dry sandpaper. Avoid cutting through and reclean decal.

(5) Spray 3M Woodgrain and Stripe Remover, or equivalent, on flange area first. Then spray entire decal to be removed (fig. 3P-1). Move spray back and forth across entire decal in a smooth steady motion. Make sure entire decal is coated with remover.

CAUTION: Woodgrain and Stripe Remover from 3M is designed for use on acrylic enamel surfaces only.

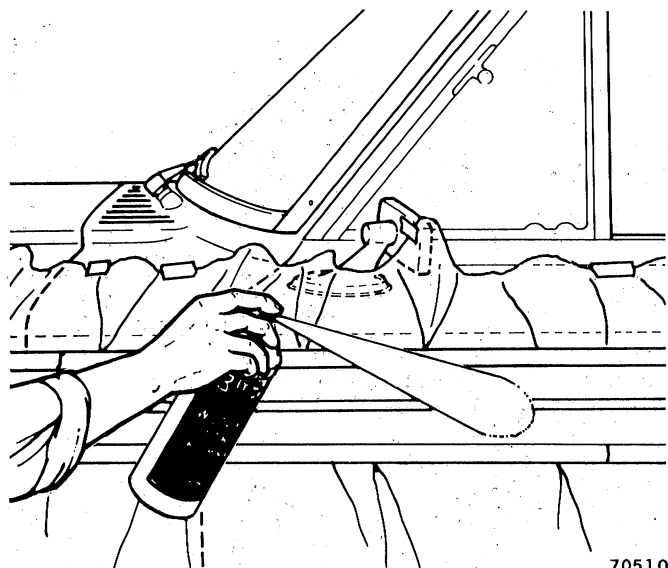

70510

Fig. 3P-1 Spraying Remover on Decal

WARNING: Use 3M Woodgrain and Stripe Remover, or equivalent, only in a well-ventilated area. Observe manufacturer's warnings printed on label.

(6) Spray entire panel again, this time moving the spray up and down the decal.

(7) Allow remover to stay on decal for 20 minutes.

(8) After 20 minutes, peel decal away from flange areas. Then, start in one corner and peel decal away from panel (fig. 3P-2). If there is any difficulty in peeling decal/overlay away from panel, use squeegee to assist in removal (fig. 3P-3).

(9) Scrape all 3M Woodgrain and Stripe Remover from surface before proceeding.

(10) After decal is removed, spray panel again with 3M Adhesive Remover, or equivalent, to remove any

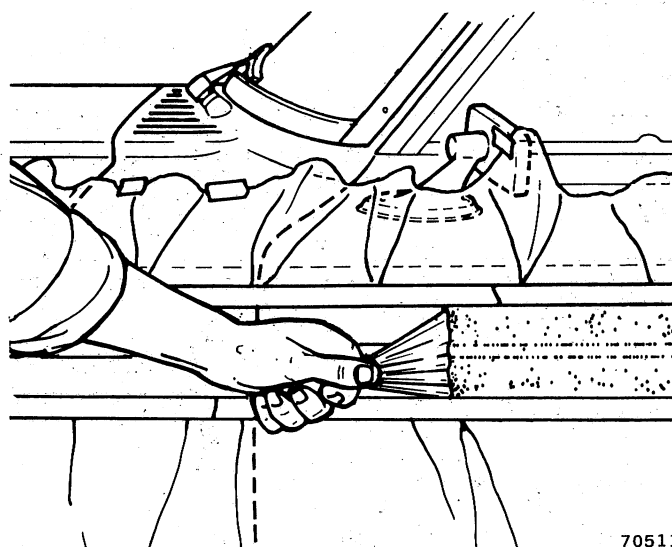

70511

Fig. 3P-2 Peeling Decal from Panel

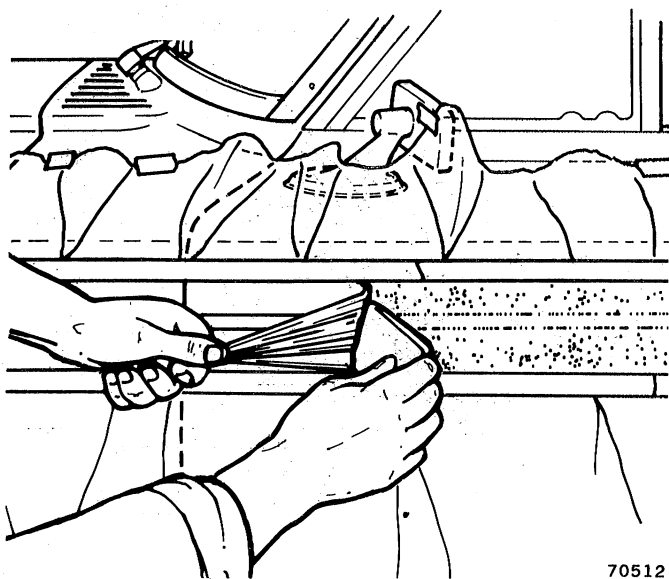

70512

Fig. 3P-3 Using Squeegee to Assist in Removal of Decal

remaining adhesive. Use slow spray application and apply in uniform criss-cross pattern to obtain heavy coat.

WARNING: Use 3M Adhesive Remover, or equivalent, only in well-ventilated area. Observe manufacturer's warnings printed on label.

CAUTION: Leaving Remover on surface for too short or long a period may render product ineffective. Allow Remover to work on adhesive surface for three to five minutes.

(11) After five minutes, use squeegee to remove adhesive residue (fig. 3P-4).

NOTE: If some adhesive is difficult to remove, spray additional remover on troublesome spots. Wait approximately two minutes and squeegee remaining spots. Repeat as necessary.

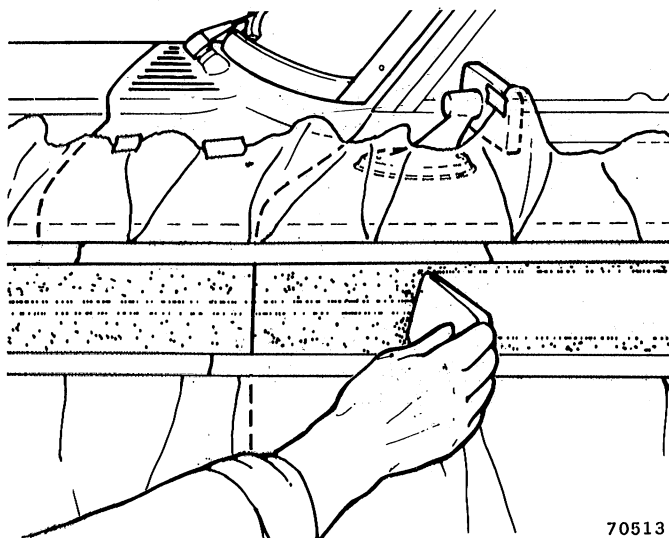

70513

Fig. 3P-4 Using Squeegee to Remove Adhesive Residue

- (12) Remove masking tape and paper.
- (13) Wash entire panel with 3M General Purpose Adhesive Cleaner, or equivalent. If any spots of adhesive remain on panel, hard rubbing during the washdown will remove them.

Installation

(1) Clean painted surface with wax and silicone remover. Use 3M General Purpose Adhesive Cleaner, or equivalent. Wipe surface with clean cloth, and allow to dry.

NOTE: Freshly painted surfaces must be thoroughly dry. Residual solvents in fresh paint may cause decal to blister.

(2) Position decal on panel surface and mark position with grease pencil (fig. 3P-5). Ensure that 1/2-inch excess is allowed to be wrapped around door and fender areas. Cut decal to approximate length using scissors.

(3) Position decal on panel and hold in place with small strips of masking tape (fig. 3P-6). Be sure decal is aligned with decals on adjacent panels.

(4) Lift decal using masking tape as hinges (fig. 3P-7).

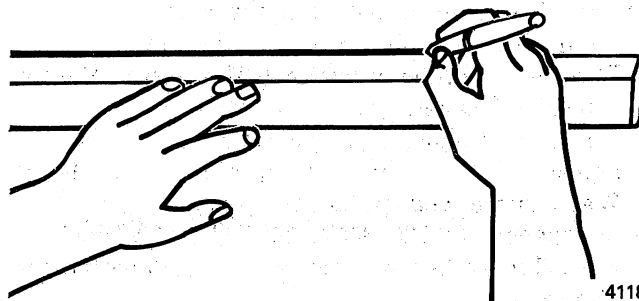

41186

Fig. 3P-5 Marking Decal Position

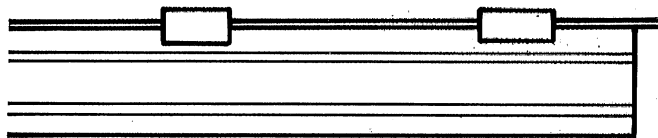
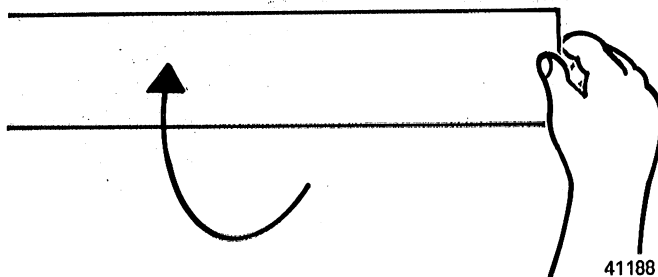

Fig. 3P-6 Positioning Decal on Panel



41188

Fig. 3P-7 Lifting Decal

(5) Remove approximately 6 inches of paper backing from one end (fig. 3P-8).

NOTE: To avoid pre-adhesion or stretching the decal, do not remove more than 6 inches of paper backing at one time.

(6) Fold decal back to aligned position. With firm strokes, squeegee decal to panel while removing paper backing (fig. 3P-9).

(7) Where possible, extend decal 1/2 inch beyond corners or edges (fig. 3P-10) and wrap firmly using finger pressure and squeegee. Avoid trapping air in these areas.

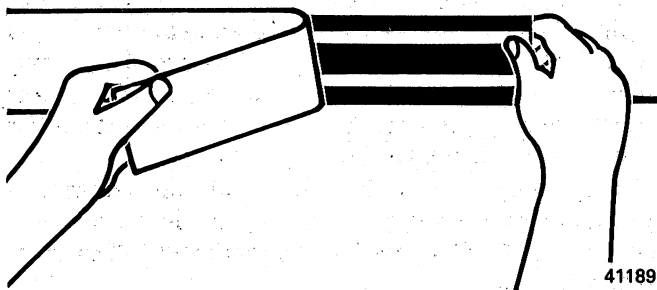

Fig. 3P-8 Removing Backing Paper

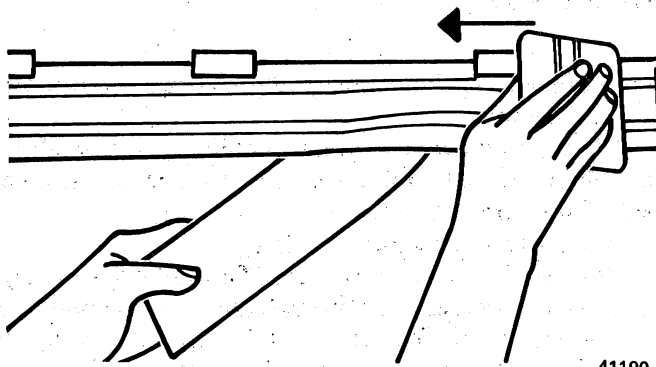

Fig. 3P-9 Installing Decal with Squeegee

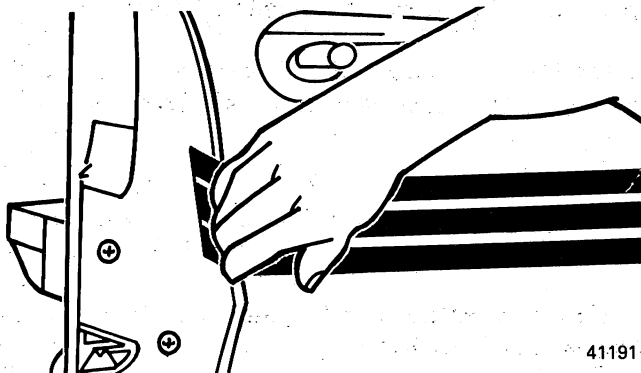

Fig. 3P-10 Installing Decal at Corners or Edges

(8) Remove easy-release paper from face of decal, if applicable.

(9) Inspect decal installation using reflected light to detect any irregularities that may have developed during installation. Remove all air or moisture bubbles.

(10) Install previously removed parts and clean up vehicle as required.

Installation of Intricate Decals

For large, intricately shaped decals, the following procedure will simplify installation.

(1) The use of wetting solution aids installation of decal. Prepare supply of wetting solution by thoroughly mixing two or three teaspoons of detergent (Joy, Vel, or equivalent) in one gallon of water.

NOTE: Too much detergent reduces the effectiveness of the bond. DO NOT USE SOAP.

(2) Place the decal on clean, flat surface with paper backing side up. Bend corner of decal toward the decorative face side, and with flick of finger, separate paper backing from decal. Hold decal firmly to surface of table and remove paper backing. Under hot, humid conditions, slight jerking motion aids in removing paper backing.

CAUTION: Always remove the paper backing from the decal; never remove the decal from the backing as stretching may result.

NOTE: Hold decal in corners when removing paper backing as fingerprints adversely affect the adhesion.

(3) Using clean sponge, apply ample wetting solution to decal adhesive and panel surface. The wetting solution permits ease of movement of decal while positioning it on panel surface.

(4) Immediately apply wetted decal to panel surface. Apply wetting solution to decorative face of decal to allow the squeegee to slip during application.

(5) Squeegee short section of decal at center. Lift right or left side of decal, position it straight and close to panel, and squeegee toward lifted edge. Avoid stretching decal at lifted end. Squeegee outward from center with firm, overlapping strokes.

(a) Lift upper area of decal (up to bonded area) and, working upward from bonded section at center, squeegee decal into place.

(b) Lift lower area of decal (up to bonded area) and, working downward from bonded section at center, squeegee decal into place.

NOTE: If a wrinkle is trapped during squeegee operations, stop immediately. Carefully lift affected section. Align the section to the panel and remove wrinkle.

EXTERIOR WOODGRAIN OVERLAYS

	Page		Page
General	3P-5	Removal	3P-6
Installation	3P-7	Repairs	3P-6
Preparation	3P-6	Vinyl Moulding Replacement—Wagoner-Cherokee and Truck	3P-8

GENERAL

Exterior woodgrain overlay panels are made of a tough, durable, weather-resistant, opaque cast vinyl and have a pressure-sensitive back. The pressure-sensitive back is protected by a paper backing which is removed at installation. The woodgrain is embedded in the cast vinyl for a longer lasting, attractive appearance.

REPAIRS

Small nicks, bruises or scratches can be touched up with paint in much the same manner as painted surfaces. Proper color match can be obtained by blending small amounts of appropriate paint colors, then spot-painting the affected area of the overlay.

To repair blisters or air bubbles, pierce them with a sharp needle or pin. Work the trapped air out through the pin hole and press the overlay firmly against the panel. It may be necessary to preheat the panel slightly with Heat Gun J-25070 to soften the adhesive. Heat also may be applied to remove small wrinkles, irregularities, or bridging which may occur in the corners of the fuel tank filler opening.

NOTE: *Whenever the material must be stretched, do not slit or cut the overlay. Simply apply heat and press or squeegee the overlay smoothly and firmly into place.*

PREPARATION

Workroom temperature should be between 65°F and 90°F. Overlays should not be replaced in temperatures below 65°F.

The following equipment and materials are necessary for a quality overlay installation.

- Woodgrain and Stripe Remover (3M, or equivalent)
- Adhesive Remover (3M, or equivalent)
- Liquid detergent (Joy, Vel, or equivalent)
- Wax and silicone remover (3M General Purpose Adhesive Cleaner, or equivalent)
- Isopropyl alcohol (rubbing alcohol)
- Squeegee (4 to 5 inches wide, plastic or hard rubber)
- Water bucket and sponge
- Sandpaper (No. 220, 360 or No. 400, wet-or-dry type)
- Heat Gun J-25070 or infrared heat bulb and extension cord

- Clean wiping rags or paper towels
- Sharp knife or single-edge razor blade or X-acto knife
- Scissors
- Sharp needle or pin
- Grease pencil

Prepare a supply of wetting solution by thoroughly mixing two or three teaspoons of detergent (Joy, Vel, or equivalent) in one gallon of water. The use of a wetting solution assures a better bond between overlay and painted surface. Too much detergent reduces the effectiveness of the bond. **DO NOT USE SOAP.**

Overlay replacement involving collision damage, or damage to underlying paint finish, requires that metal repair and refinish operations be completed before overlay is installed.

REMOVAL

- (1) Clean repair surfaces, adjacent panels and openings as required.
- (2) Remove overlay reveal mouldings, door handles, lock assembly, side marker lamps or other overlapping parts from affected panel.
- (3) Mask off area surrounding panel.
- (4) Scuff sand overlay with 220 grade wet or dry sandpaper. Avoid cutting through and reclean overlay.
- (5) Spray 3M Woodgrain and Stripe Remover, or equivalent, on flange area first. Then spray entire overlay to be removed (fig. 3P-11). Move spray can back and forth across entire overlay with smooth steady motion. Make sure entire overlay is coated with remover.

CAUTION: *Woodgrain and Stripe Remover from 3M is designed for use on acrylic enamel surfaces only.*

WARNING: *Use 3M Woodgrain and Stripe Remover, or equivalent, only in a well-ventilated area. Observe manufacturer's warnings printed on label.*

- (6) Spray entire panel again, this time moving spray up and down overlay.
- (7) Allow remover to stay on overlay for 20 minutes.

(8) After 20 minutes, peel overlay away from flange areas. Then, start in one corner and peel overlay away from panel (fig. 3P-12). If there is any difficulty in peeling overlay away from panel, use squeegee to assist in removing it (fig. 3P-13).

(9) Scrape all Woodgrain and Stripe Remover from surface before proceeding.

(10) After overlay is removed, spray panel again with 3M Adhesive Remover, or equivalent, to remove any remaining adhesive. Use slow spray application and apply remover in uniform criss-cross pattern to obtain heavy coat.

WARNING: Use 3M Adhesive Remover, or equivalent, only in well-ventilated area. Observe manufacturer's warnings printed on label.

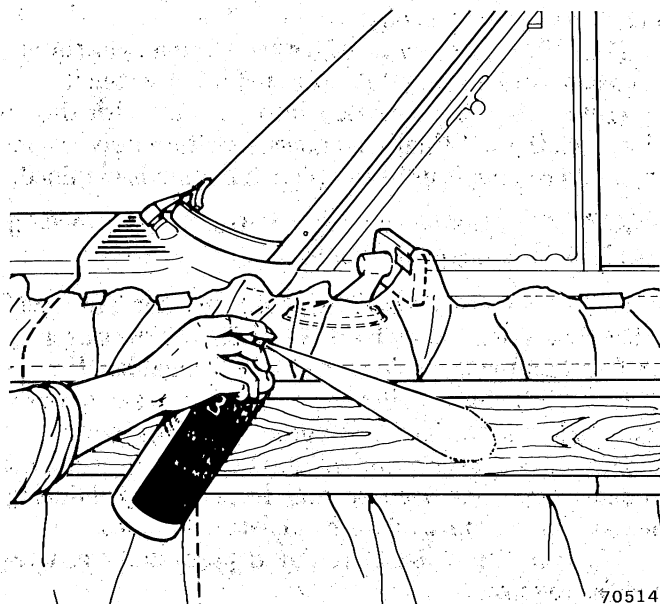

Fig. 3P-11 Spraying Remover on Overlay

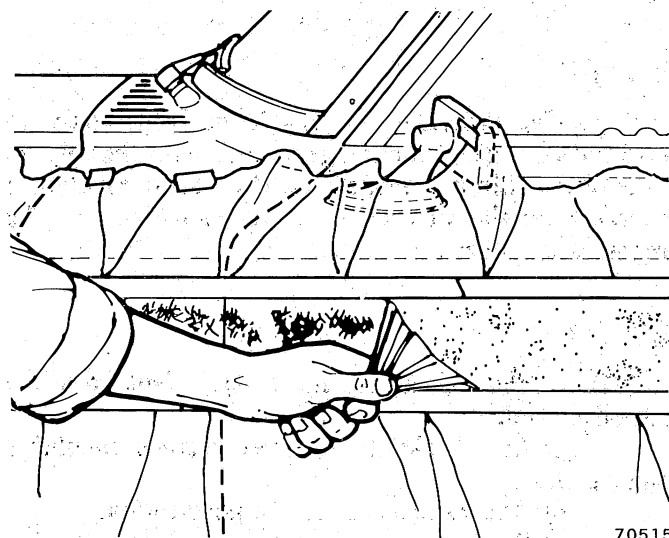

Fig. 3P-12 Peeling Overlay from Panel

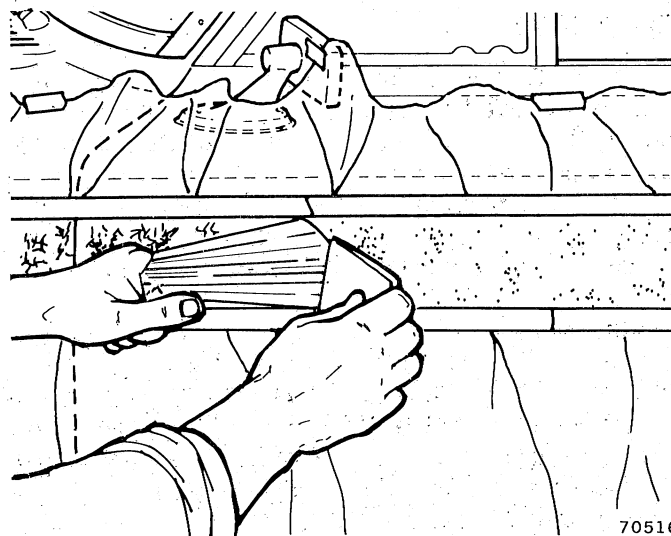

Fig. 3P-13 Using Squeegee to Assist in Removal of Overlay

CAUTION: Leaving remover on surface for too short or long period may render product ineffective. Allow remover to work on adhesive surface for three to five minutes.

(11) After five minutes, use squeegee to remove adhesive residue (fig. 3P-14).

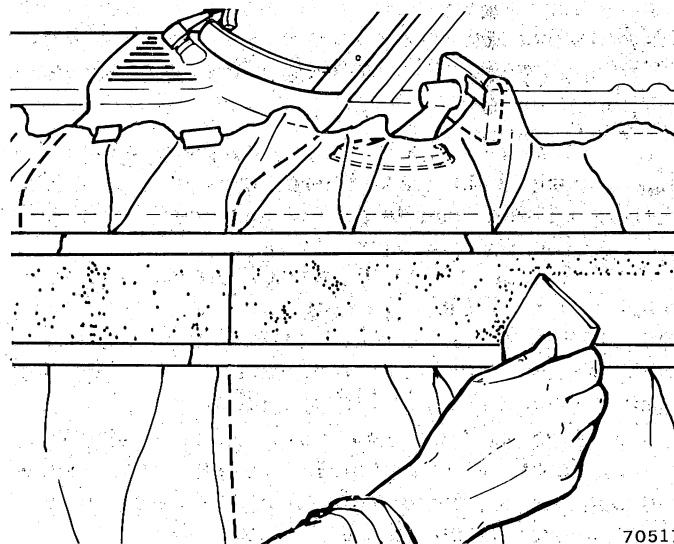

Fig. 3P-14 Using Squeegee to Remove Adhesive Residue

NOTE: If some adhesive is difficult to remove, spray additional remover on troublesome spots. Wait approximately two minutes and squeegee remaining spots. Repeat as necessary.

(12) Remove masking tape and paper.

(13) Wash entire panel with 3M General Purpose Adhesive Cleaner, or equivalent. If any spots of adhesive remain on panel, hard rubbing during the washdown will remove them.

INSTALLATION

(1) Scuff-sand painted surface with 360 or 400 sandpaper by dry sanding. Freshly painted surfaces must be thoroughly dry. Residual solvents in fresh paint may cause overlay to blister.

(2) Clean painted surfaces with wax and silicone remover (3M General Purpose Adhesive Cleaner, or equivalent). Wipe surface with clean cloth and allow to dry.

(3) Position overlay on repair panel surface, and mark approximate outline on overlay with grease pencil. Ensure that 1/2-inch excess is allowed to be wrapped around the door and fender areas. With scissors, cut overlay to approximate size. Overlay should be cut so that upper and lower edges extend halfway into area covered by mouldings.

(4) Place overlay on clean, flat surface with protective paper backing side up. Bend corner of overlay toward decorative face side, and with flick of finger, separate paper backing from overlay. Hold overlay firmly to surface of table and remove paper backing. Under hot, humid conditions, slight jerking motion aids in removing paper backing.

CAUTION: Always remove the paper backing from the overlay; never remove the overlay from the backing as stretching may result.

NOTE: Hold overlay by corners when removing paper backing as fingerprints adversely affect the adhesion.

(5) Using clean sponge, apply ample wetting solution to overlay adhesive and to repair panel surface. The wetting solution permits ease of movement of overlay while positioning it on panel surface.

(6) Immediately apply wetted overlay to repair panel surface. Position overlay in center of area to be covered with at least 3/8 inch extending beyond edges. Apply wetting solution to woodgrain surface of overlay to allow squeegee to slip during application.

(7) Squeegee from center to edges of overlay with firm strokes to remove all air bubbles and wetting solution and to assure bonding of overlay to painted surface. On large overlays, simplify installation as follows:

(a) Squeegee a short, 4 to 6-inch horizontal section of overlay at center of panel. Lift right or left side of overlay, position it straight and close to panel, and squeegee toward lifting edge. Avoid stretching overlay at lifted end; squeegee progressively from middle with firm, overlapping strokes.

(b) Lift upper area of overlay (up to bonded area) and, working upward from bonded section at center, squeegee overlay into place.

(c) Lift lower area of overlay (up to bonded area) and, working downward from bonded section at center, squeegee overlay into place.

NOTE: If a wrinkle is trapped during squeegee operations, stop immediately. Carefully lift affected section. Realign section to panel and progressively remove wrinkle. Do not lift overlay if only a few bubbles are trapped.

(8) Notch corner or curved edges of overlay where necessary and trim off excess material.

(9) Allow 3/8-inch extra material beyond edges that are to be wrapped around flange areas, or align locating tab with edge.

CAUTION: Use extreme care to avoid spilling isopropyl alcohol (rubbing alcohol) on trim or painted surfaces. Wipe spills immediately as alcohol will discolor trim or painted surfaces on prolonged contact.

(10) To activate adhesive, wipe adhesive side of overlay with isopropyl alcohol.

(11) Warm overlay at edges by passing heat source, such as Heat Gun J-25070, over surface to soften it.

(12) Firmly press overlay into position with fingertips, a cloth, and finally a squeegee, alternately warming and pressing it until complete adhesion is obtained.

NOTE: Avoid undue pulling or stretching at ends of overlay as tearing could result.

(13) Apply heat to overlay at side marker lamps and other depressions using Heat Gun J-25070. Press overlay uniformly into depressions to obtain formed bond.

(14) With sharp knife, carefully cut out excess overlay at side marker lamps and other openings in panel.

(15) Inspect overlay installation using reflected light to detect irregularities that may have developed during installation. Remove all air or moisture bubbles.

(16) Install previously removed parts and clean vehicle as required.

VINYL MOULDING REPLACEMENT—WAGONEER-CHEROKEE AND TRUCK**General**

Some Wagoneer, Cherokee and Truck models have an optional vinyl scuff moulding on the sides of the vehicle. The Wagon Limited model has vinyl scuff mouldings surrounding the woodgrain. These mouldings can be replaced as follows.

Replacement

(1) Use 3M Release Agent, or equivalent, to soften adhesive bond.

(a) Use shorkel tube, spray between moulding and panel.

(b) Allow 2 to 3 minutes for penetration.

(c) Spray second application and wait 3 minutes for adhesive bond to soften.

- (2) Peel moulding from panel.
- (3) Clean any adhesive residue from surface with cloth dampened with 3M General Purpose Adhesive Cleaner, or equivalent.
- (4) To insure proper moulding alignment, stretch piece of string at desired level along panel and secure ends with tape.
- (5) Position moulding on vehicle with backing tape attached, and cut to fit.

- (6) Peel away backing tape and press moulding to panel with roller or heavy hand pressure, parallel with string.
- (7) Remove string.
- (8) Check moulding alignment and trim moulding with razor blade, if necessary.
- (9) If moulding comes loose apply 3M Plastic and Emblem Adhesive, or equivalent, to moulding surface and press firmly to body.

Tools

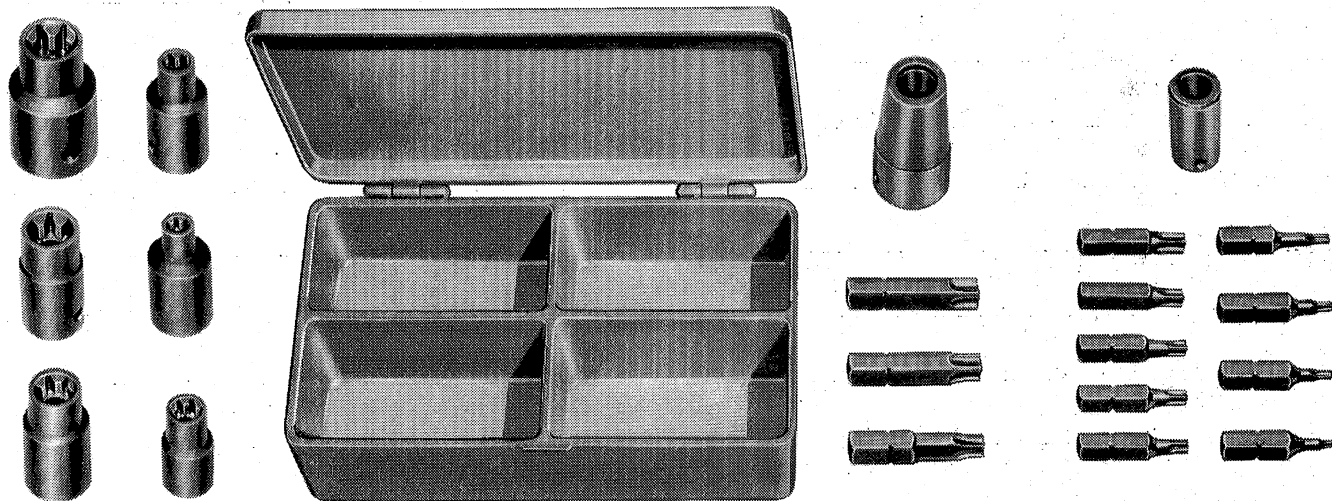

J-25359-C—TORX BIT SET

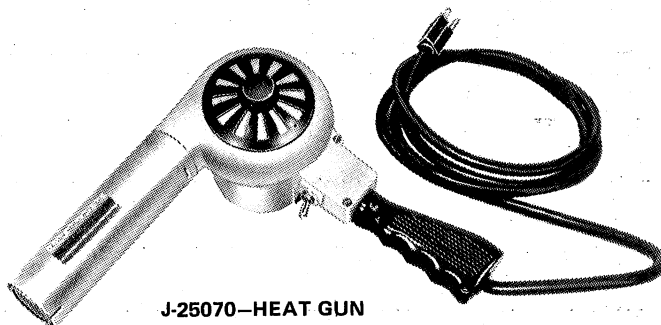

J-25070—HEAT GUN

NOTES

[Faint, illegible text and markings on lined paper]