

STARTING SYSTEMS

1F

SECTION INDEX

	Page		Page
Four-Cylinder Engine Starting System	1F-1	Six- and Eight-Cylinder Engine Starting System	1F-11

FOUR-CYLINDER ENGINE STARTING SYSTEM

	Page		Page
General	1F-1	Starter Motor Operation	1F-1
Neutral Safety Switch Replacement	1F-5	Starter Motor Relay Replacement	1F-5
Service Diagnosis	1F-1	Starter Motor Replacement	1F-5
Specifications	1F-11	Tools	1F-25
Starter Motor General Diagnosis	1F-9		

GENERAL

The four-cylinder engine starter motor system consists of a 5MT starter motor, relay, ignition/start switch, battery and related electrical wiring. In addition, vehicles equipped with an automatic transmission have a neutral safety switch. These components are connected electrically as illustrated in figure 1F-1.

STARTER MOTOR OPERATION

The 5MT starter motor is shown in figure 1F-2. The field windings are permanently mounted in the motor frame. Both the shift lever mechanism and the solenoid plunger are enclosed in the drive housing to protect them from exposure to dirt, icing conditions and water splash.

In the basic circuit illustrated in figure 1F-1, the solenoid is energized when the ignition/starting key switch is closed. The resulting plunger and shift lever movement causes the pinion gear to engage the engine flywheel (or drive plate) ring gear and the solenoid main contacts to close, and engine cranking is initiated. When the engine starts, the pinion gear overrun clutch protects the armature from excessive speed until the switch is opened, at which time the return spring disengages the pinion gear. To prevent excessive overrun, the key switch should be released immediately after the engine starts.

Neutral Safety Switch

The Neutral Safety Switch is a three-connector plunger switch mounted on the automatic transmission case. The outside terminals connect to the back-up lamps, while the center terminal provides a ground path for the starter motor relay circuit. Ground is provided only when the transmission is in Park or Neutral position.

NOTE: *Automobiles equipped with an automatic transmission have a neutral safety switch that provides a ground for the starter motor relay (G-terminal) when the automatic transmission selector is in either the NEUTRAL or PARK position. When the relay is energized, battery voltage is applied to the starter motor solenoid pull-in and hold-in coil windings. If equipped with a manual transmission, a jumper wire attached to the back-up lamp connector provides a ground for the starter motor relay (G-terminal).*

SERVICE DIAGNOSIS

Before removing any unit from the starter motor system for repair, perform the following inspections.

(1) **Battery:** To determine condition of battery, follow testing procedure outlined in Chapter 1D—Batteries.

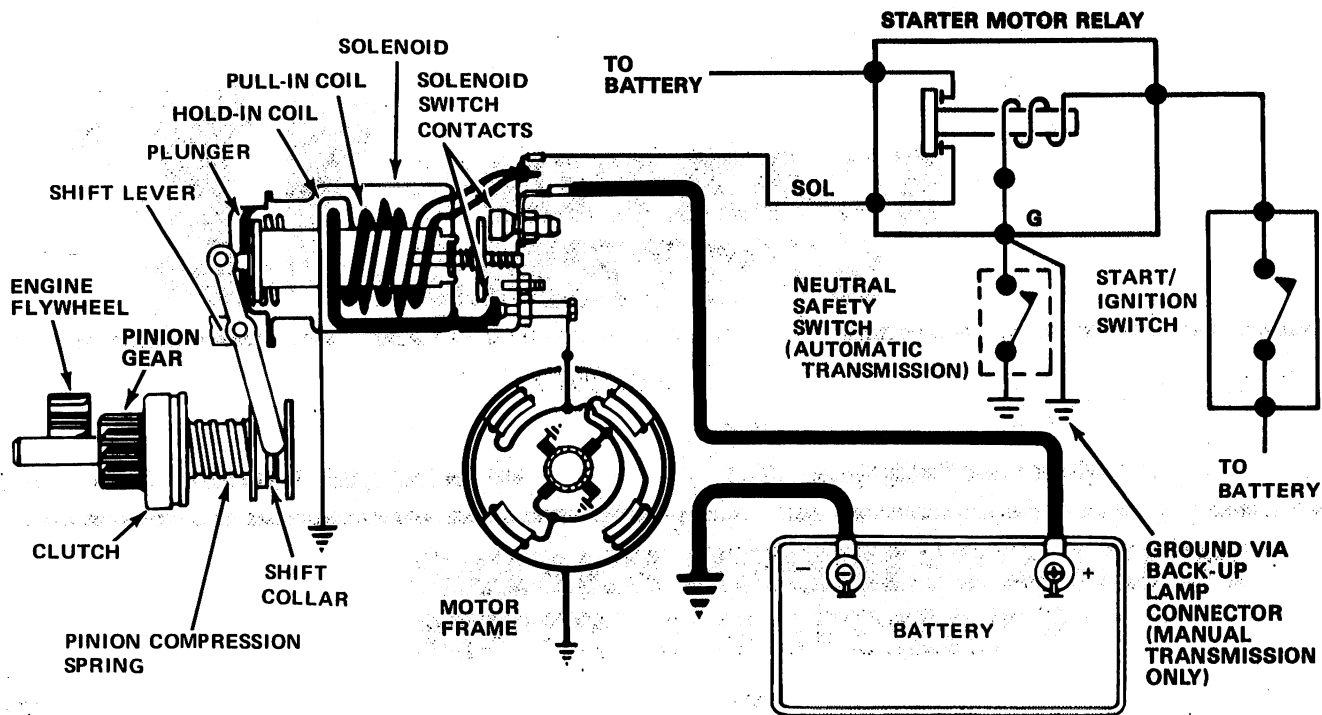

90558

Fig. 1F-1 Four-Cylinder Engine Starter Motor System

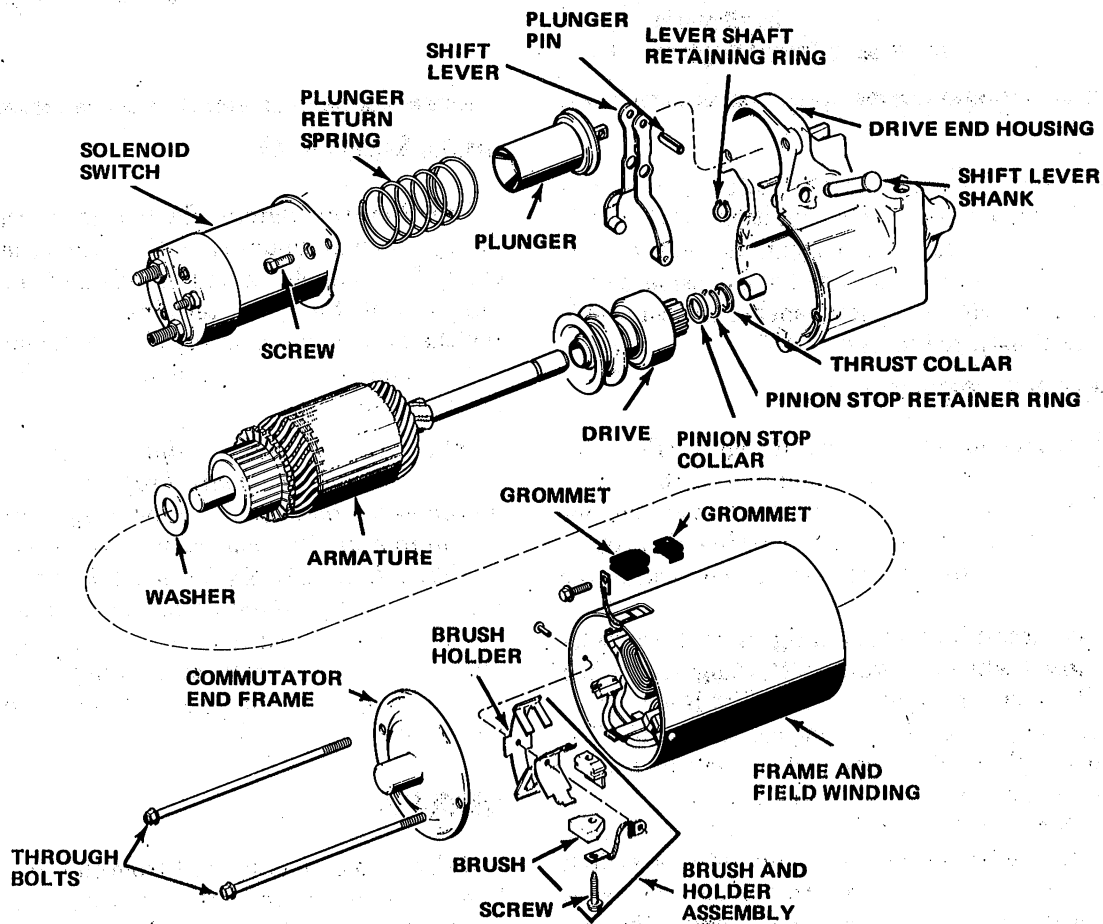

90556

Fig. 1F-2 5MT Starter Motor—Exploded View

(2) **Wiring:** Inspect wiring for damage. Inspect all connections at starter motor solenoid, relay (if equipped), neutral safety switch (if equipped), ignition/start switch, and battery, including all ground connections. Clean and tighten all connections as required.

(3) **Solenoid and Ignition/Start Switch:** Inspect solenoid and switch to determine their condition. Also, if equipped with automatic transmission, inspect condition of starter motor relay.

(4) **Starter Motor Noise:** To correct starter motor noise during starting, use the following procedure:

(a) Refer to Starter Motor Noise Diagnosis Chart to determine problem.

(b) If complaint is similar to first two conditions, correction can be achieved by proper "shimming" as follows.

1. Remove flywheel or drive plate ring gear inspection plate.

2. Inspect flywheel or drive plate and ring gear for damage; i.e., warp, unusual wear and excessive runout. Replace flywheel, ring gear or drive plate as necessary.

3. Disconnect battery negative cable (to prevent inadvertent cranking of engine).

NOTE: Two shim thicknesses are available. One is 0.015 inch (0.381 mm) and the other 0.045 inch (1.143 mm). If shims are not available, they can be fabricated from plain washers or other suitable material.

4. If complaint is similar to first condition, starter motor must be moved toward flywheel/drive plate. This can be accomplished by shimming (fig. 1F-3) only outboard starter motor mounting pad. (This is generally condition that causes broken flywheel ring gear teeth or starter motor housings).

5. If complaint is similar to second condition, starter motor must be moved away from flywheel/drive plate. This is accomplished by installing shim(s) (fig. 1F-3). More than one shim may be required.

(c) Conditions 3 and 4 may require starter motor replacement or repair in some instances.

(5) **Starter Motor:** If battery, wiring, switches, solenoid and relay (if equipped) are in satisfactory condition, and engine is known to be functioning properly, remove starter motor and follow test procedures outlined below.

CAUTION: Never operate the starter motor more than for a 30-second duration without pausing to allow it to cool for at least two minutes. Overheating, caused by excessive cranking, will seriously damage the starter motor.

Starter Motor Test

A general diagnosis is described at the end of this section. Once a problem has been traced to the starter motor, proceed to the test procedure outlined below.

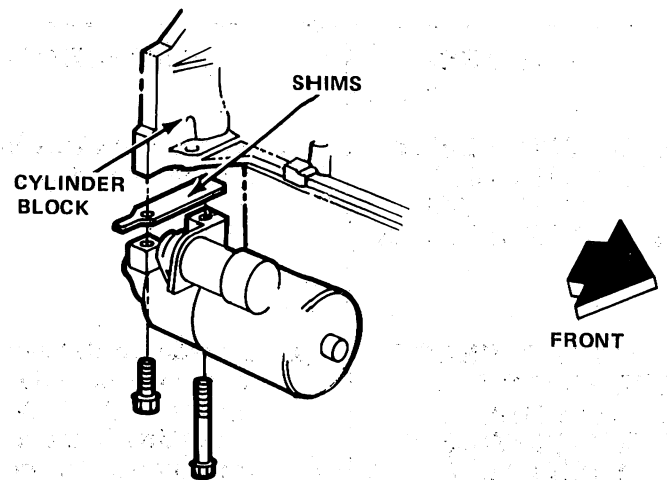

90557

Fig. 1F-3 Starter Motor Shimming and Mounting

Test Procedure

With the starter motor removed from the engine, the pinion gear should be tested for freedom of operation by turning it on the screw shaft. The armature should be tested for freedom of rotation by prying the pinion gear with a screwdriver to engage it with the shaft. Tight bearings, a bent armature shaft, or a bent frame will cause the armature to not rotate freely. If the armature does not rotate freely, the motor should be disassembled immediately. However, if the armature does rotate freely, the motor should be given a no-load test before disassembly.

No-Load Test

Connect a voltmeter (fig. 1F-4) between the motor terminal and the motor frame, and use a tachometer to measure armature speed. Connect the motor and an ammeter in series with a fully charged battery of the specified voltage, and a switch (in the open position) from the solenoid battery terminal to the solenoid switch terminal. Close the switch and compare the rpm, current, and voltage with those listed in the specifications. It is not necessary to obtain the exact voltage specified because an accurate interpretation can be made by recognizing that if the voltage is slightly higher, the rpm will be proportionately higher, with the current remaining the same. However, if the exact voltage is desired, a carbon pile rheostat connected across the battery can be used to reduce the voltage to the specified value. The specified current flow includes the solenoid current flow. Make disconnections only with the switch open. Interpret the test results as follows:

(1) Rated current flow and specified no-load speed indicate normal condition of starter motor.

Starter Motor Noise Diagnosis

CONDITION	POSSIBLE CAUSE	CORRECTION
HIGH FREQUENCY WHINE BEFORE ENGINE STARTS; ENGINE STARTS OK.	(1) Excessive distance between pinion gear and flywheel/drive plate gear.	(1) Shim starter motor toward flywheel /drive plate.
HIGH FREQUENCY WHINE AFTER ENGINE STARTS WITH IGNITION KEY RELEASED. ENGINE STARTS OK.	(1) Insufficient distance between starter motor pinion gear and flywheel/drive plate gear. Flywheel/drive plate runout can cause noise to be intermittent.	(1) Shim starter motor away from flywheel/drive plate. Inspect flywheel/drive plate for damage; bent, unusual wear, and excessive runout. Replace flywheel/drive plate as necessary.
A LOUD "WHOOOP" AFTER ENGINE STARTS WHILE STARTER MOTOR IS ENGAGED.	(1) Most probable cause is defective overrunning clutch. Clutch replacement normally corrects this condition.	(1) Replace overrunning clutch or drive assembly.
A "RUMBLE", "GROWL" OR "KNOCK" AS STARTER MOTOR COASTS TO STOP AFTER ENGINE STARTS.	(1) Most probable cause is bent or unbalanced starter motor armature. Armature replacement normally corrects this condition.	(1) Replace starter motor armature.

90804

(2) Low no-load speed and high current flow indicate:

(a) Too much friction—tight, dirty, or worn bearings, bent armature shaft or bent frame causing armature to drag.

(b) Shorted armature winding. This can be further determined on growler after disassembly.

(c) Grounded armature or field windings. Inspect further after disassembly.

(3) No armature rotation and high current flow indicate:

(a) Terminal or field windings shorted to ground.

(b) Seized bearings (this should have been determined by turning armature by hand).

(4) No armature rotation and no current flow indicate:

(a) Open field winding circuit. This can be determined after disassembly by inspecting internal connections and testing circuit with test lamp.

(b) Open armature windings. Inspect commutator for badly burned bars after disassembly.

(c) Broken brush springs, worn brushes, protruding insulation between commutator bars or other causes that would prevent good contact between brushes and commutator.

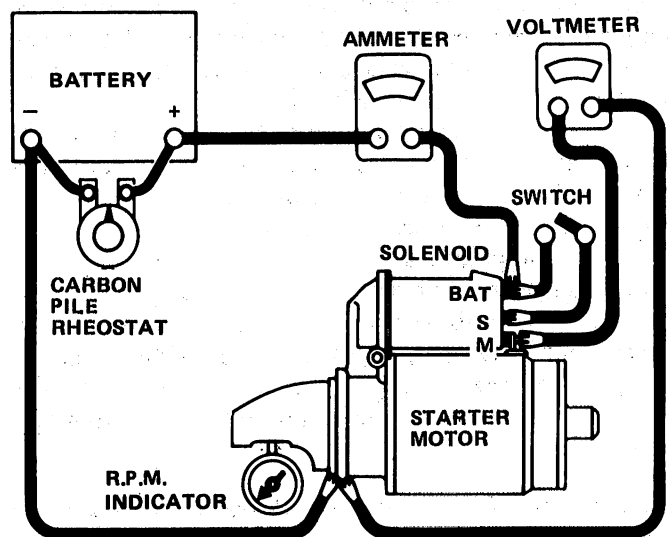

90559

Fig. 1F-4 No-Load Test Connections

(5) Low no-load speed and low current flow indicate high internal resistance because of poor connections, defective wires, dirty commutator and causes listed under step (4) above.

(6) High no-load speed and high current flow usually indicate shorted field windings. If shorted field windings are suspected, replace field winding and frame assembly and retest for improved performance. In some instances, armature winding could also be shorted. Test on growler.

Starter Motor Relay Test

(1) Disconnect wire connectors from I-terminal and G-terminal.

(2) Measure resistance between terminals with ohmmeter. Correct resistance is 23 ohms (approximately).

(3) Measure resistance between either terminal and battery negative post. Resistance should be infinite.

(4) If defective, replace relay. If acceptable, connect wire connectors.

(5) Remove SOL-terminal wire connector and connect voltmeter between terminal and battery negative post.

(6) With ignition/start switch in start position, voltmeter should indicate battery voltage (12 volts).

(7) If defective, replace relay. If acceptable, connect wire connector.

Neutral Safety Switch Test

Disconnect wire connector from switch and test for continuity with ohmmeter between center terminal pin and transmission case. Continuity should exist only when automatic transmission is in Park or Neutral position.

NOTE: Check linkage adjustment before replacing switch.

STARTER MOTOR REPLACEMENT

Starter motors do not require lubrication except during overhaul.

When the motor is disassembled for any reason, lubricate as follows:

(1) Armature shaft and drive end and commutator end bushings should be covered with a thin coating of Lubriplate, or equivalent.

(2) Roll type overrunning clutch requires no lubrication. However, drive assembly should be wiped clean. **Do not** clean in degreasing tank or with grease dissolving solvents because this will dissolve lubricant in clutch mechanism. Use silicone grease (General Electric CG321, Dow Corning 33 Medium, or equivalent) on shaft underneath overrunning clutch assembly.

NOTE: Avoid excessive lubrication.

Starter Motor Removal

Use the following procedure to remove the starter motor from the engine:

(1) Disconnect battery negative cable at battery.

(2) From beneath vehicle, remove two starter motor-to-engine bolts (fig. 1F-3), and allow starter to drop down.

(3) Disconnect solenoid wires and battery cable, and remove starter motor. To replace, reverse procedure outlined above. Replace any shims that were removed.

Solenoid Removal

Use the following procedure to remove the solenoid from the starter motor:

(1) Disconnect field strap.

(2) Remove solenoid-to-drive housing attaching screws, motor terminal bolt, and remove solenoid by twisting.

(3) Replace by reversing procedure outlined above.

STARTER MOTOR RELAY REPLACEMENT

(1) Disconnect battery negative cable.

(2) Identify, tag and disconnect wires attached to relay.

(3) Remove relay attaching screws and relay from inner fender panel.

(4) Install replacement relay on inner fender panel.

(5) Connect wires to relay.

(6) Connect battery negative cable.

(7) Test relay operation.

NEUTRAL SAFETY SWITCH REPLACEMENT

(1) Disconnect wiring connector and remove switch from transmission. Allow fluid to drain into container.

(2) Move selector lever to Park and Neutral positions. Inspect switch operating lever fingers to ensure they are properly centered in switch opening.

(3) Install switch and seal on transmission case. Tighten switch with 24 foot-pounds (6 N•m) torque.

(4) Test switch continuity.

(5) Correct transmission fluid level as required.

STARTER MOTOR OVERHAUL

If the starter motor does not function correctly (as described in the No-Load Test above), it should be disassembled for further testing of the components. The starter motor should be disassembled only enough to permit repair or replacement of the defective parts. Safety glasses should be worn when disassembling or assembling the starter motor.

Disassembly

The following procedure should be used to disassemble and reassemble the starter motor. Component inspections are also included. Refer to figure 1F-2 and proceed as follows:

- (1) Disconnect field winding connection from solenoid terminal.
- (2) Remove through-bolts.
- (3) Remove commutator end frame and field frame assembly.
- (4) Remove armature assembly from drive housing. Remove solenoid and shift lever assembly from drive housing before removing armature assembly.
- (5) Remove thrust collar from armature shaft.
- (6) Remove pinion gear from armature by sliding metal cylinder onto shaft and by striking metal cylinder against retainer with hammer. Drive retainer toward armature core and off snap ring (fig. 1F-5).
- (7) Remove snap ring from groove in armature shaft.

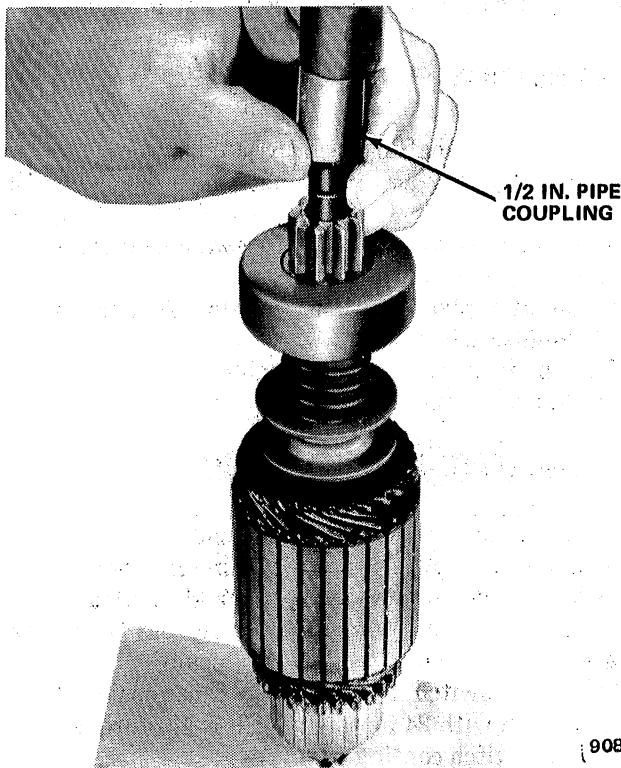

Fig. 1F-5 Removing Retainer From Snap Ring

(8) Roller type clutches are designed to be serviced as a complete unit. Do not disassemble, replace if necessary.

Component Inspection

- **Brushes and Brush Holders**—Inspect the brushes for wear. If they are worn excessively when compared with a new brush, they should be replaced.

Ensure the brush holders are clean and the brushes are not binding in the holders. The complete brush surface should ride on the commutator for proper operation. Check by hand to ensure that the brush springs are providing firm contact between the brushes and commutator. If the springs are distorted or discolored, they should be replaced.

- **Armature Windings**—Commutators should not have the insulation undercut, and out-of-round commutators should **not** be turned in a lathe. The armature windings should be tested for internal short circuits, open circuits, and shorts to ground:

(1) Internal short circuits are located by rotating armature in growler with steel strip (e.g., hacksaw blade) held above armature. Steel strip will vibrate when at area of short circuit. Short circuits between commutator bars are sometimes caused by brush dust or copper imbedded between bars. Cleaning dust and copper out of bars may eliminate short circuits.

(2) Open circuits can be located by inspecting connections joining armature windings to commutator bars for looseness. Loose connections cause arcing and burning of commutator bars. If bars are not badly burned, winding connections to bars can be resoldered.

(3) Shorts to ground in armature windings can be detected by use of test lamp. If lamp lights when one test probe is placed on commutator bar and the other test probe on armature core or shaft, armature winding is shorted to ground. Test all windings.

- **Field Windings**—The field windings should be tested for shorts to ground and open circuits with a test lamp. The field winding circuit is illustrated in figure 1F-1.

(1) Shorts to grounds—Disconnect field winding ground connection. Connect one test lamp probe to motor frame and other to field winding connector. If lamp lights, field windings are shorted to ground and must be repaired or replaced. If windings are not shorted, reconnect winding to ground. This test cannot be made if ground connection cannot be disconnected.

(2) Open circuits—Connect test lamp probes to frame and field winding connector. If lamp does not light, field windings are open. If field windings are found to be defective, frame and field winding assembly must be replaced. Windings cannot be replaced separately because of integral frame construction.

- **Solenoid**—A basic solenoid circuit is diagramed in figure 1F-1. Solenoids can be tested electrically by connecting a battery of the specified voltage, a switch, and an ammeter to the two solenoid windings. With all wires disconnected from the solenoid,

make test connections to the solenoid switch terminal and to ground to test the hold-in winding (fig. 1F-6). Use the carbon pile rheostat across the battery to decrease the battery voltage to the value listed in specifications. Compare the current flow with the value listed in Specifications. A high current flow indicates a shorted or grounded hold-in winding, and a low current flow indicates excessive resistance.

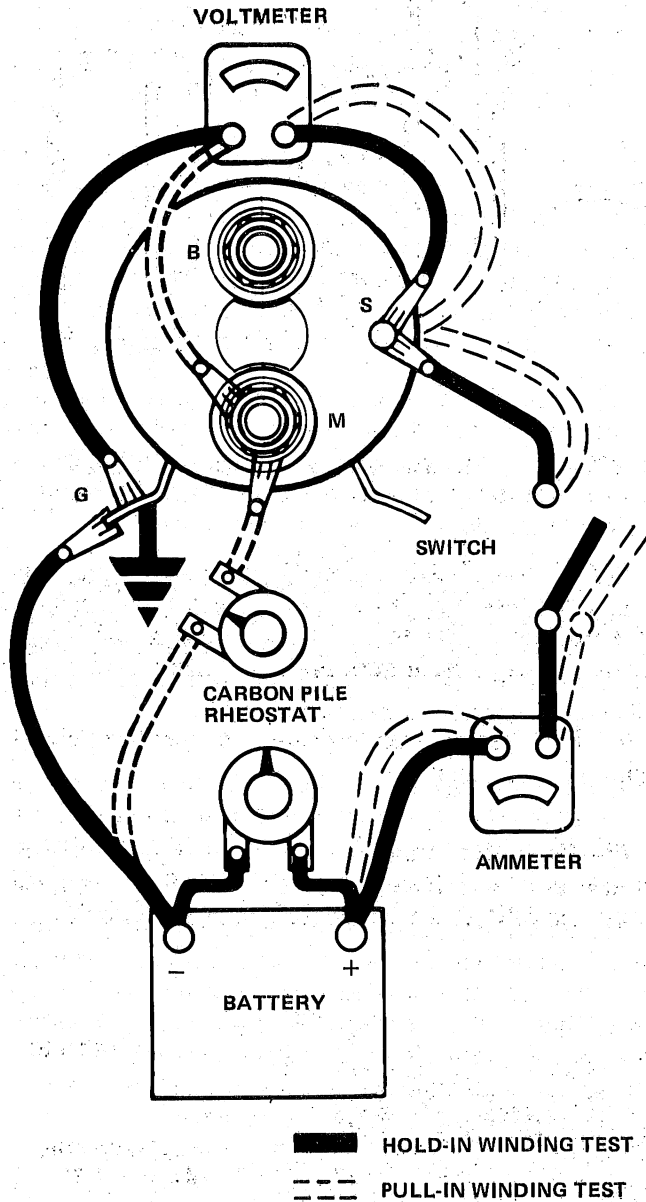

Fig. 1F-6 Solenoid Test Connections 90561

To test the pull-in winding, connect the battery across the solenoid switch (S) terminal and the Solenoid motor (M) terminal. To reduce the voltage to the specified value, connect the carbon pile rheostat between the battery and M-terminal as shown with dashed lines (fig. 1F-6) instead of across the battery as shown with solid lines. If not needed, connect a jumper directly from the battery to the M-terminal.

CAUTION: To prevent overheating, do not allow the pull-in winding to be energized more than 15 seconds. The current flow will decrease as the winding temperature increases.

• **Overrunning Clutch**—Test the overrunning clutch action. The pinion gear should turn freely in the overrunning direction. Inspect the pinion gear teeth to ensure that they have not been chipped, cracked, or excessively worn. Replace assembly if necessary. Badly chipped pinion gear teeth indicate possible chipped teeth on the ring gear. The ring gear should be examined and replaced if necessary.

Test the overrunning clutch for slipping with the clutch attached to the armature. Wrap the armature with a shop towel and clamp in a vise. Using a 12-point deep socket and torque wrench, place the socket on the clutch and turn counterclockwise. The clutch should not slip with up to 50 foot-pounds (68 N•m) torque applied. If it does, replace the clutch.

Assembly

(1) Position clutch assembly on armature shaft. To replace snap ring and retainer onto armature:

(a) Position retainer on armature shaft with cupped surface facing snap ring groove.

(b) Position snap ring on end of shaft. With piece of wood on top, force ring over shaft and tap in place (fig. 1F-7), then slide ring down into groove.

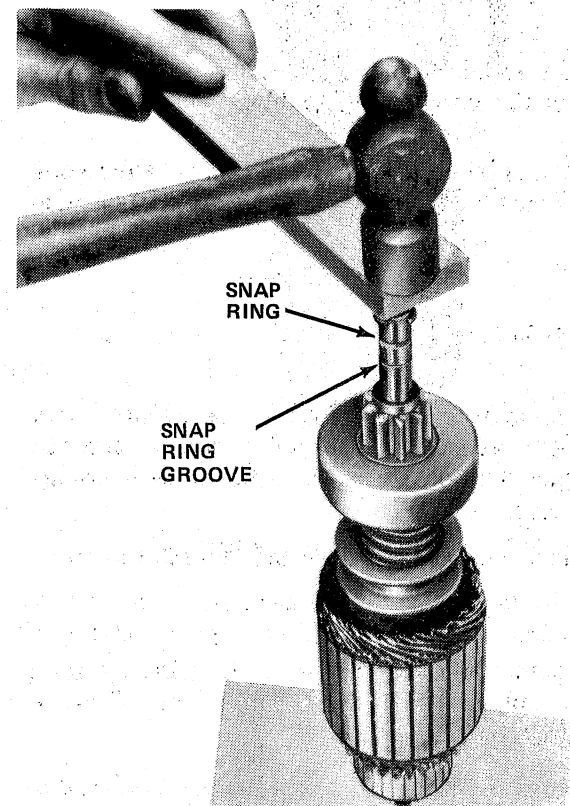
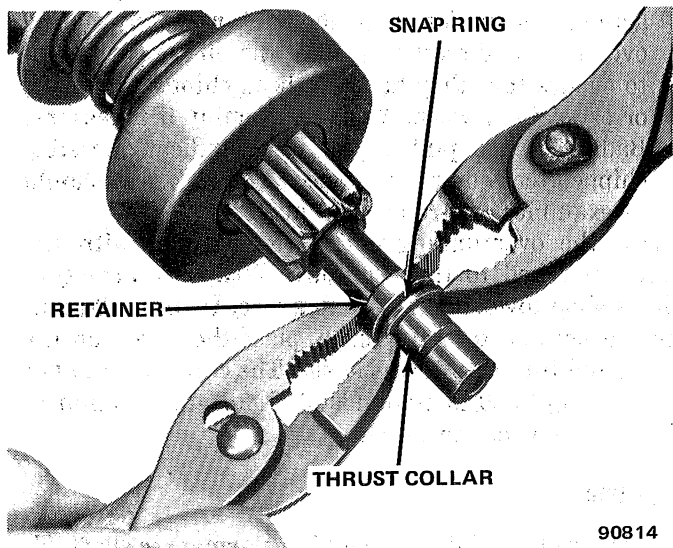

Fig. 1F-7 Forcing Snap Ring Over Shaft 90813

(c) To force retainer over snap ring, place a suitable washer over shaft and squeeze retainer and washer together with pliers (fig. 1F-8).



90814

Fig. 1F-8. Forcing Retainer Over Snap Ring

(d) Remove washer.

(e) Slide thrust collar over shaft.

(2) Refer to disassembly procedure and follow in reverse order to complete reassembly.

(3) When solenoid is installed, apply sealing compound between motor frame, flange, and solenoid junction.

Pinion Gear Clearance Test

The pinion gear clearance cannot be adjusted but should be tested after reassembly of the starter motor to ensure proper clearance. Improper clearance is an indication of worn parts.

To measure pinion gear clearance, follow the steps listed below:

(1) Disconnect starter motor field winding connector from solenoid motor M-terminal and THOROUGHLY INSULATE IT.

(2) Connect battery between solenoid switch S-terminal and starter motor frame (fig. 1F-9).

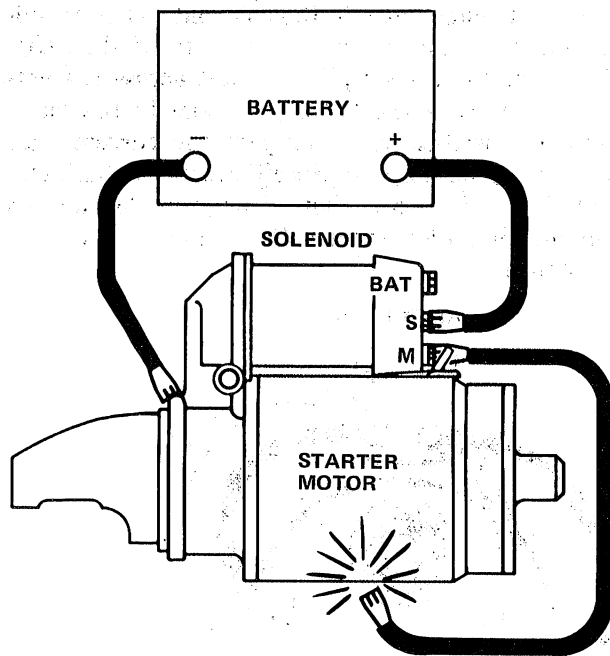

90560

Fig. 1F-9 Pinion Gear Clearance Measurement Test Circuit

(3) MOMENTARILY flash jumper lead from solenoid motor terminal (M) to starter motor frame. This will shift pinion gear into cranking position and it will remain in this position until battery is disconnected.

(4) Push pinion gear back toward commutator end to eliminate any slack.

(5) Measure distance between pinion gear and pinion gear stop with feeler gauge (fig. 1F-10). Acceptable distance is 0.010 to 0.140 inch (0.0254 to 3.556 mm).

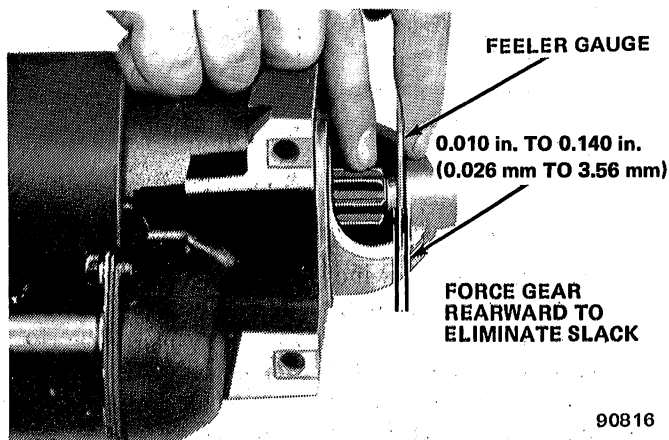

90816

Fig. 1F-10 Measuring Pinion Gear Clearance

Starter Motor General Diagnosis
SOLENOID DOES NOT ENERGIZE

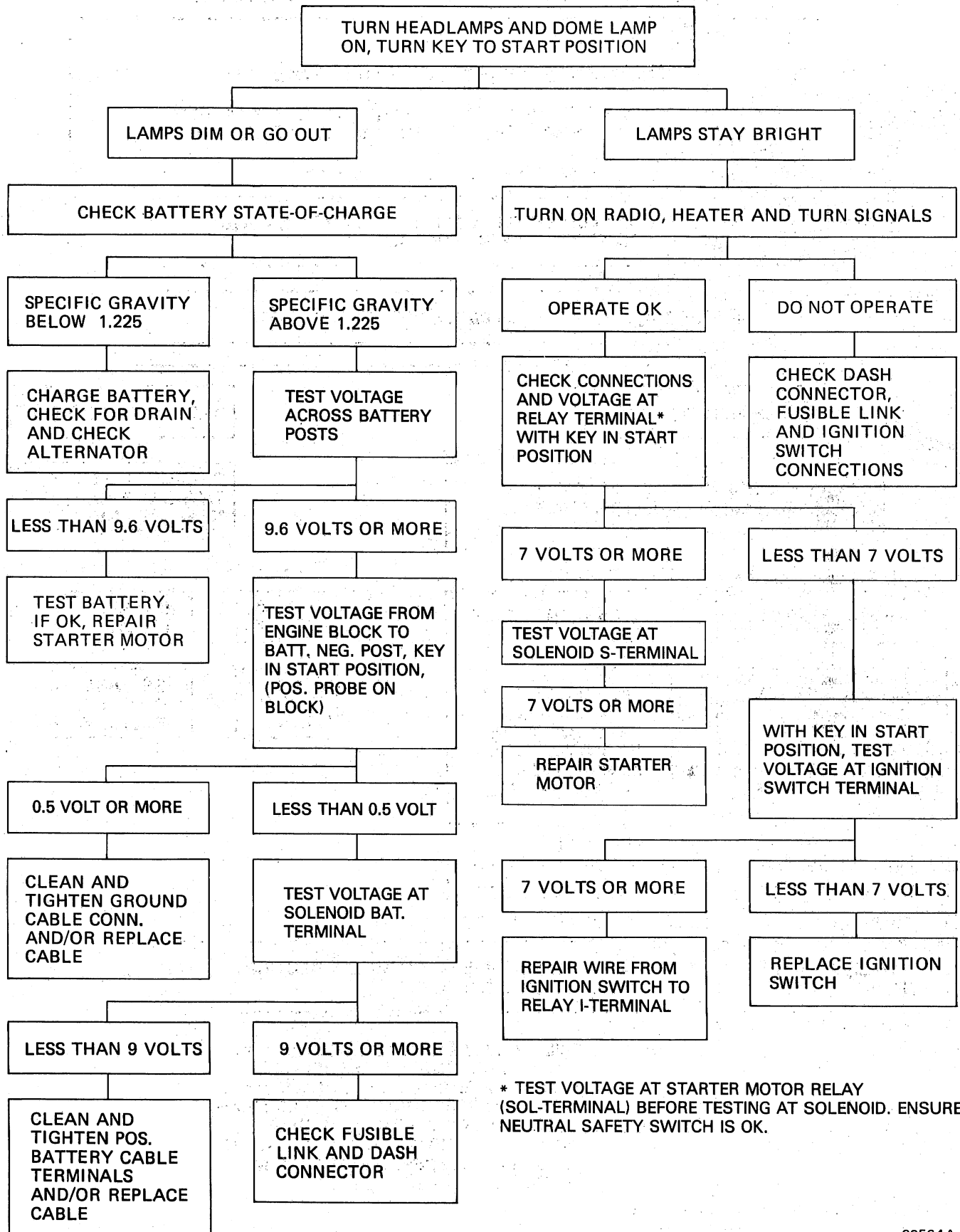

* TEST VOLTAGE AT STARTER MOTOR RELAY (SOL-TERMINAL) BEFORE TESTING AT SOLENOID. ENSURE NEUTRAL SAFETY SWITCH IS OK.

Starter Motor General Diagnosis (Continued)

SLOW MOTOR OPERATION, SOLENOID CLICKS OR CHATTERS

TEST BATTERY STATE-OF-CHARGE
 PERFORM VISUAL INSPECTION OF BATTERY CABLES AND CONNECTIONS
 IF BATTERY NEEDS CHARGING, MAKE ALTERNATOR AND BATTERY DRAIN TEST, CHARGE BATTERY AND RECHECK MOTOR OPERATION. IF TROUBLE HAS NOT BEEN FOUND, PROCEED.

REMOVE 12-VOLT CONNECTOR FROM HEI DISTRIBUTOR. MAKE ALL VOLTMETER TESTS WITH KEY IN START POSITION.

MEASURE VOLTAGE ACROSS BATTERY TERMINAL POSTS

9.6 VOLTS OR MORE

LESS THAN 9.6 VOLTS

MEASURE VOLTAGE FROM BATTERY NEGATIVE TERMINAL TO ENGINE BLOCK. (POS. PROBE ON BLOCK)

CHARGE AND CONNECT TEST BATTERY. MEASURE VOLTAGE

0.5 VOLT OR MORE

LESS THAN 0.5 VOLT

LESS THAN 9.6 VOLTS

9.6 VOLTS OR MORE

REPAIR GROUND CABLE AND CONNECTIONS

MEASURE VOLTAGE AT SOLENOID BAT. TERMINAL, CLEAN AND TIGHTEN ALL CONNECTIONS AT STARTER MOTOR.

REPAIR STARTER MOTOR

REPLACE ORIGINAL BATTERY

9 VOLTS OR MORE

LESS THAN 9 VOLTS

REPAIR STARTER MOTOR

CLEAN AND TIGHTEN POSITIVE CONNECTIONS IF OK, REPLACE CABLE

NOTE: THIS DIAGNOSIS IS DESIGNED FOR USE ON ENGINES AND BATTERIES AT ROOM OR NORMAL OPERATING TEMPERATURES. IT IS ALSO NECESSARY THAT THERE BE NO ENGINE DEFECTS THAT WOULD CAUSE STARTER MOTOR PROBLEMS. TO USE IT UNDER OTHER CONDITIONS CAN RESULT IN AN INCORRECT DIAGNOSIS.

SPECIFICATIONS

STARTER MOTOR AND SOLENOID									
ENGINE	STARTER		NO LOAD TEST WITH 9 VOLTS				SOLENOID		
	PART NO.	TYPE	AMPS		RPM		PART NO.	SPECIFICATIONS	
			MIN.	MAX.	MIN.	MAX.		HOLD-IN WINDING AMPS AT 10V	PULL-IN WINDING AMPS AT 5V
151 (2V)	1109526	5MT	45	70	7000	11,900	1114488	15-20	20-30

90565

SIX-AND EIGHT-CYLINDER ENGINE STARTING SYSTEM

	Page		Page
Components	1F-11	Specifications	1F-25
General	1F-11	Starter Motor Overhaul	1F-21
Neutral Safety Switch Replacement	1F-24	Starter Motor Replacement	1F-21
Off-Vehicle Testing	1F-18	Tools	1F-25
On-Vehicle Testing	1F-14	Troubleshooting	1F-14
Operation	1F-12		

GENERAL

The starting system used with all Jeep six- and eight-cylinder engines consists of a lightweight positive engagement starter motor, a starter motor solenoid, an ignition/start switch, circuits protected by fusible links and the battery. Vehicles equipped with an automatic transmission also have a neutral safety switch. The starter motor has a moveable pole shoe and appropriate linkage to engage the drive mechanism. Inside the drive assembly, an overrunning clutch prevents the starter motor from being driven by the ring gear.

COMPONENTS

Starter Motor

Identification

At the time of manufacture, the starter motor identification code is stamped on the frame adjacent to the Jeep part number. The date is decoded as follows:

- Year (1—1981) (2—1982)
- Month (A—Jan., B—Feb., etc.)
- Week (A—first week in month, B—second week, etc.)

Field Windings

Four field windings are used. Each is wound around an iron pole shoe that concentrates the electromagnetic

flux created when current flows through the field winding. Three of the field windings have fixed pole shoes, while the fourth winding has a moveable pole shoe. This fourth winding, located at the top of the starter motor, has an additional, smaller winding wound inside of it. This is the hold-in winding.

Drive Assembly

A pinion gear, driven by the starter motor armature, is forced to move into mesh with the engine flywheel (or drive plate) ring gear when the starter motor is actuated. The movement is accomplished by the action of the moveable pole shoe and its drive yoke (fig. 1F-11). As long as the ignition key is held in the **Start** position, the pinion gear remains in mesh with the ring gear. An overrunning (one-way) clutch in the drive assembly permits the starter motor to drive the ring gear, but after the engine starts, the clutch prevents the engine from driving the starter motor before the key is released to the **On** position.

Starter Motor Solenoid

Two different starter motor solenoids are used, one with manual transmissions and the other with automatic transmissions. The solenoids differ only in the method of providing a ground for the solenoid pull-in winding.

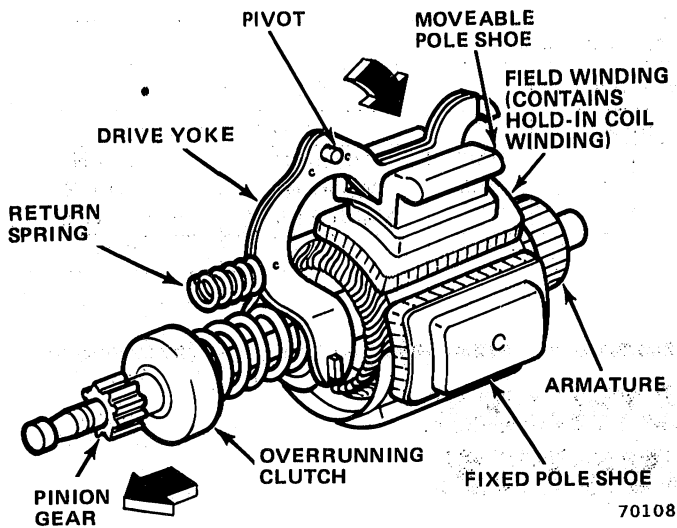

Fig. 1F-11 Moveable Pole Shoe Operation

The ground circuit for the solenoid pull-in winding is completed through the solenoid mounting bracket on manual transmission equipped vehicles.

On vehicles equipped with an automatic transmission, the pull-in winding is grounded through an additional terminal on the bottom of the solenoid. A wire connected to this terminal provides a ground path from the neutral safety switch located on the transmission. The pull-in winding ground circuit is completed at the neutral safety switch only when the automatic transmission gear selector is placed in Neutral or Park.

NOTE: The neutral safety switch and back-up lamp switch are enclosed in a single housing.

The starter motor solenoid pull-in winding is energized when battery voltage is applied to the S-terminal of the solenoid and the pull-in winding is grounded. When the solenoid pull-in winding is energized, the contact disc is forced into the closed position. The disc mates with two contacts in the solenoid and this completes the circuit between the battery and the starter motor.

All starter motor solenoids have an I-terminal that is connected to the ignition system. When the starter motor is in operation, the I-terminal provides full battery voltage for the ignition coil. This circuit bypasses the resistance wire that provides voltage for the coil after the engine starts. Refer to Chapter 1G—Ignition Systems for additional information.

CAUTION: Starter motor solenoids used in previous years (before solid-state ignitions) look similar to the solenoids presently used but are very different internally. Use of the wrong type solenoid can damage the neutral safety switch. Verify the part number stamped on the replacement solenoid before installation.

CAUTION: Starter motor solenoids are equipped with both blade terminals and long studs. The blade terminals are attached to the long studs and held in place by retaining nuts. Loosening of the retaining nuts could cause the loss of internal connections and necessitate replacement of the solenoid.

Neutral Safety Switch

The Neutral Safety Switch is a three-terminal plunger switch mounted on the automatic transmission case. The two outer terminals connect to the back-up lamp circuit, while the center terminal provides a ground path for the starter motor solenoid circuit. Ground is provided only when the automatic transmission is in Park or Neutral position.

Starting System Circuits

The starting system has two electrical circuits, a low current circuit and a high current circuit (fig. 1F-12). The low current circuit is the control circuit. It includes the connections and wires leading from the ignition switch to the S-terminal on the starter motor solenoid, and from the ground terminal of the starter motor solenoid to the neutral safety switch on automatic transmission equipped vehicles. The high current circuit runs from the battery through the starter motor solenoid to the starter motor to ground. This circuit uses heavy gauge cables because of the large current flow required for the starter motor.

Fusible Link

A fusible link is used in the low current starting system circuit (fig. 1F-12). Current flows from the starter motor solenoid battery terminal by cable to the battery positive terminal. From the solenoid battery terminal, voltage is also distributed to other vehicle circuits. A 14-gauge fusible link is connected between the solenoid terminal and the main body wire harness. This fusible link protects the complete vehicle electrical system as well as the solenoid.

Fusible links are covered with a special non-flammable insulation. Each link is manufactured with a specific load rating and is intended for a specific circuit. Replacement links are available from Jeep service parts sources.

OPERATION

The starter motor low current circuit is controlled by the ignition/start switch (fig. 1F-12). The ignition/start switch applies battery voltage to the starter motor solenoid S-terminal when the ignition key is in the **Start** position. This energizes the solenoid pull-in winding, which completes the high current circuit between the battery and the starter motor. The starter motor is

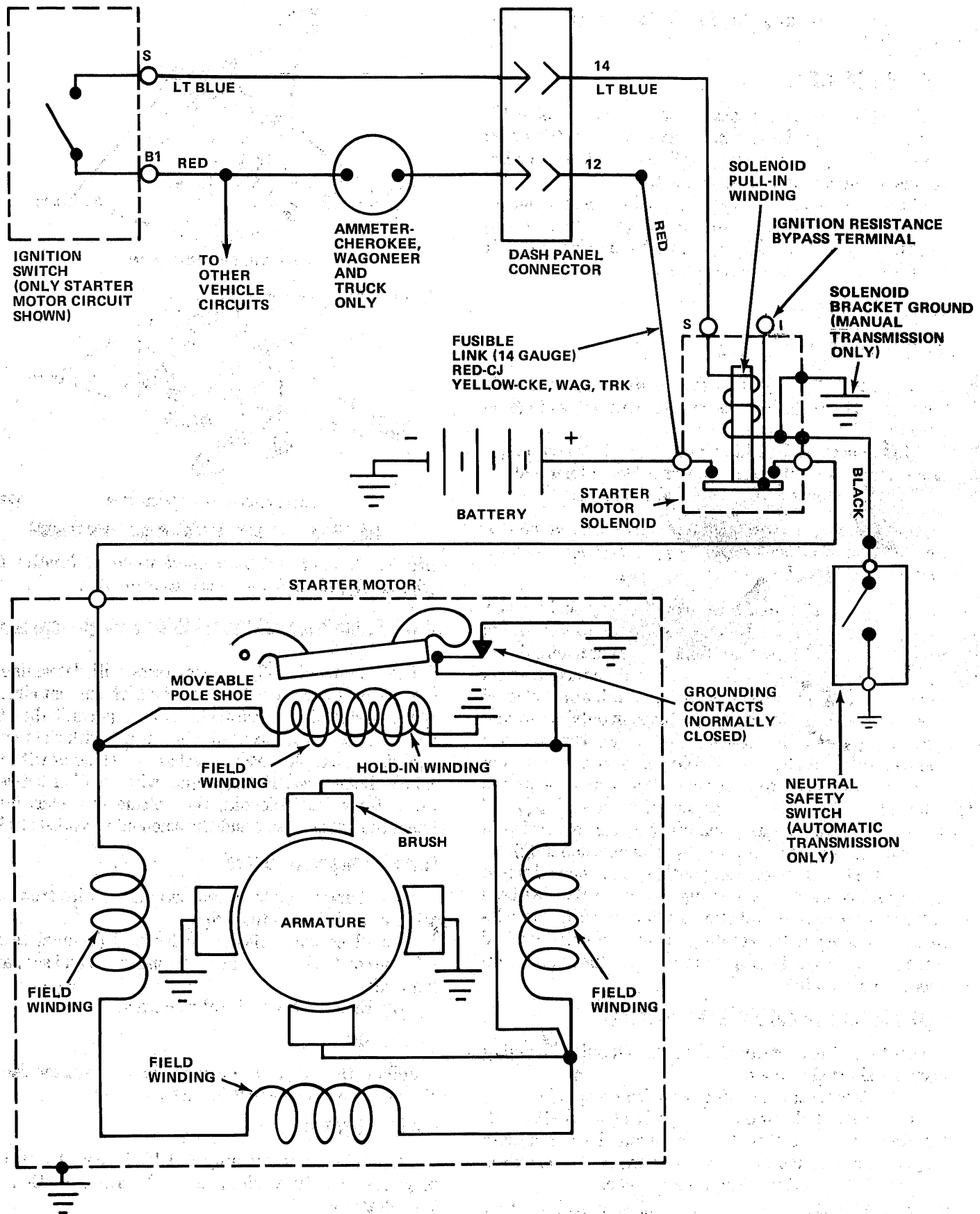

Fig. 1F-12 Six- and Eight-Cylinder Engine Starting System Schematic

then actuated and begins rotating the engine crankshaft.

TROUBLESHOOTING

The Service Diagnosis chart may be used to isolate the source of the problem when the starter motor either rotates the engine too slowly, will not rotate the engine, or has abnormal drive engagement.

If the starter motor rotating speed is normal and the drive pinion gear engages properly with the ring gear but the engine does not start, a problem exists either in the fuel system or ignition system.

ON-VEHICLE TESTING

Starter Motor Will Not Rotate

(1) Verify battery and cable condition as outlined in Chapter 1D—Batteries to assure correct voltage is available.

(2) Inspect and tighten battery and starter motor cable connections at starter motor solenoid terminals.

(3) Disconnect wire at solenoid S-terminal.

WARNING: Place transmission in Neutral (manual) or Park (automatic) position and apply parking brake before conducting solenoid test.

(4) Connect jumper wire from battery positive post to solenoid S-terminal. If starter motor rotates, solenoid is not defective. Inspect ignition/start switch circuit.

(5) If starter motor does not rotate, connect another jumper wire from battery negative terminal to solenoid mounting bracket (manual transmission only) or ground terminal (automatic transmission only). Ensure good connection is made. If solenoid energizes, it was not properly grounded. Remove rust or corrosion and attach solenoid to inner-fender panel with cadmium-plated screws (manual transmission only) or test operation of neutral safety switch (automatic transmission only).

(6) If starter motor does not rotate, remove jumper wires and connect heavy gauge jumper cable between battery positive post and starter motor terminal on solenoid. If starter motor rotates, solenoid is defective and must be replaced. If starter motor does not rotate, inspect starter motor.

Starter Motor Solenoid Pull-In Winding Test

This test will determine if the solenoid pull-in winding is either shorted or open.

(1) Disconnect S-terminal wire from solenoid.

(2) Connect ohmmeter test probes (fig. 1F-13) to S-terminal and mounting bracket (manual transmission only) or ground terminal (automatic transmission only).

(3) If solenoid fails test, replace solenoid.

NOTE: A poor solenoid ground can be determined by connecting one ohmmeter lead to the battery negative terminal and other lead to S-terminal. If resistance is

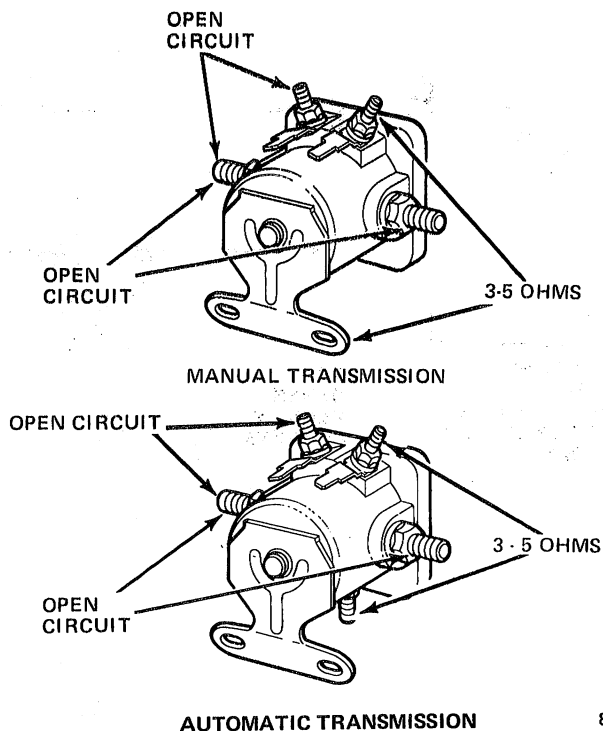

Fig. 1F-13 Ohmmeter Test of Starter Motor Solenoid

greater than in the S-terminal-to-mounting bracket test (fig. 1F-13), the solenoid has a poor ground.

Starter Motor Cable and Ground Cable Tests (Voltage Drop)

The results of voltage drop tests will determine if there is excessive resistance in the high current circuit. When performing these tests, it is important that the voltmeter test lead probes be in contact with the terminals that the cables are connected to instead of with the cables themselves. For example, when testing between the battery and solenoid, the voltmeter probes must touch the battery post and the solenoid threaded stud.

Preliminary Preparation for Tests

(1) Remove ignition coil secondary wire from distributor and ground to engine.

(2) Place transmission in Neutral (manual transmission) or Park (automatic transmission) and set parking brake.

(3) Ensure battery is fully charged.

Test Procedure

Follow the steps as outlined in the Starter Motor Voltage Drop Tests DARS charts.

Full Load Current Test

(1) Prior to performing full load current test, battery must be fully charged as described in Chapter 1D—Batteries.

NOTE: The lower the available voltage, the higher the current flow.

Service Diagnosis

Condition	Possible Cause	Correction
<p>STARTER MOTOR ROTATES ENGINE SLOWLY</p>	<ul style="list-style-type: none"> (1) Battery charge low or battery defective. (2) Defective circuit between battery and starter motor. (3) Low load current. (4) High load current. 	<ul style="list-style-type: none"> (1) Charge or replace battery. (2) Clean and tighten, or replace cables. (3) Bench-test starter motor. Inspect for worn brushes and weak brush springs. (4) Bench-test starter motor. Check engine for friction, drag or coolant in cylinders. Check ring gear-to-pinion gear clearance.
<p>STARTER MOTOR WILL NOT ROTATE ENGINE</p>	<ul style="list-style-type: none"> (1) Battery charge low or battery defective. (2) Faulty solenoid. (3) Damaged drive pinion gear or ring gear. (4) Starter motor engagement weak. (5) Starter motor rotates slowly with high load current. (6) Engine seized. 	<ul style="list-style-type: none"> (1) Charge or replace battery. (2) Check solenoid ground. Repair or replace as necessary. (3) Replace damaged gear(s). (4) Bench-test starter motor. (5) Inspect drive yoke pull-down and point gap, check for worn end bushings, check ring gear clearance. (6) Repair engine.
<p>STARTER MOTOR DRIVE WILL NOT ENGAGE (SOLENOID KNOWN TO BE GOOD)</p>	<ul style="list-style-type: none"> (1) Defective contact point assembly. (2) Inadequate contact point assembly ground. (3) Defective hold-in coil. 	<ul style="list-style-type: none"> (1) Repair or replace contact point assembly. (2) Repair connection at ground screw. (3) Replace field winding assembly.
<p>STARTER MOTOR DRIVE WILL NOT DISENGAGE</p>	<ul style="list-style-type: none"> (1) Starter motor loose on flywheel housing. (2) Worn drive end bushing. (3) Damaged ring gear teeth. (4) Drive yoke return spring broken or missing. 	<ul style="list-style-type: none"> (1) Tighten mounting bolts. (2) Replace bushing. (3) Replace ring gear or driveplate. (4) Replace spring.
<p>STARTER MOTOR DRIVE DISENGAGES PREMATURELY</p>	<ul style="list-style-type: none"> (1) Weak drive assembly thrust spring. (2) Hold-in coil defective. 	<ul style="list-style-type: none"> (1) Replace drive mechanism. (2) Replace field winding assembly.
<p>LOW LOAD CURRENT</p>	<ul style="list-style-type: none"> (1) Worn brushes. (2) Weak brush springs. 	<ul style="list-style-type: none"> (1) Replace brushes. (2) Replace springs.

STARTER MOTOR VOLTAGE DROP TEST DIAGNOSIS AND REPAIR SIMPLIFICATION (DARS) CHARTS

Note: Refer to Chapter A – General Information for details on how to use this DARS chart.

STARTER MOTOR VOLTAGE DROP TESTS

Chart 1

STEP

SEQUENCE

RESULT

STARTER MOTOR FULL LOAD CURRENT TEST

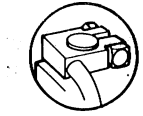

● CLEAN AND CONNECT BATTERY CABLES



● REMOVE COIL WIRE FROM DISTRIBUTOR AND CONNECT TO GROUND

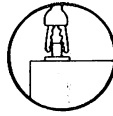

● CONNECT HEAVY LOAD TESTER

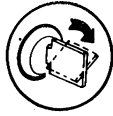

● ENGAGE STARTER MOTOR FOR THREE SECONDS AND OBSERVE VOLTMETER

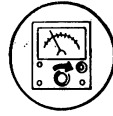

● TURN LOAD CONTROL UNTIL VOLTMETER INDICATES SAME VOLTAGE AS WHEN STARTER MOTOR WAS ENGAGED

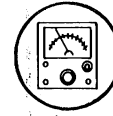

● OBSERVE AMMETER. NOTE AMPS FOR USE IN LATER STEPS.

1

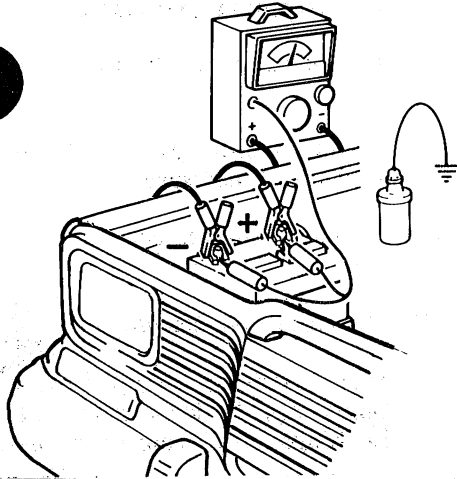

6 CYL. – 150-180 AMPS
8 CYL. – 160-210 AMPS



6 CYL. – ABOVE 180 AMPS
8 CYL. – ABOVE 210 AMPS

● BATTERY CABLES AND SOLENOID NOT TESTED

2

OR

● BATTERY CABLE AND SOLENOID REPAIRS COMPLETED



REPAIR STARTER



**VOLTAGE DROP TEST
(NOTE TEST POINTS IN ILLUSTRATION)**

- GROUND COIL WIRE
- CONNECT VOLTMETER
- ENGAGE STARTER MOTOR
- OBSERVE VOLTMETER
- COMPARE AMPS FROM STEP 1 AND VOLTS TO CHART

MAXIMUM VOLTAGE DROP BY FULL LOAD AMPERAGE				
AMPS	150-210	215-295	300-420	425-600
VOLTS	0.5 V	0.7 V	1.0 V	1.5 V

2

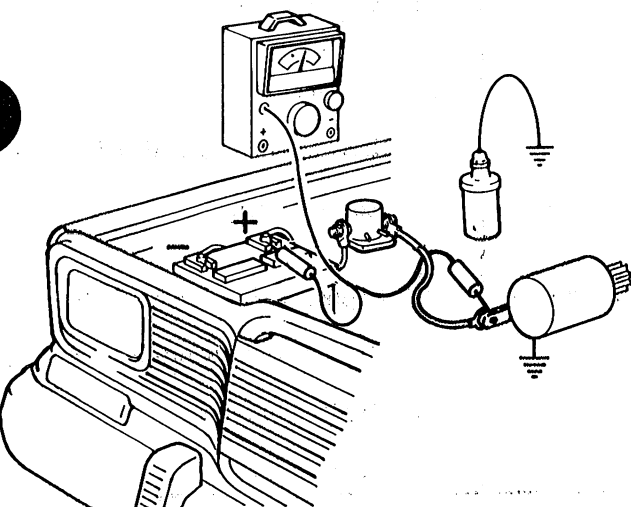

VOLTAGE AT OR BELOW MAXIMUM

5



VOLTAGE ABOVE MAXIMUM

3

STEP

SEQUENCE

RESULT

VOLTAGE DROP TEST
(NOTE TEST POINTS IN ILLUSTRATION)

- GROUND COIL WIRE
- CONNECT VOLTMETER
- ENGAGE STARTER MOTOR
- OBSERVE VOLTMETER
- COMPARE AMPS FROM STEP 1 AND VOLTS TO CHART

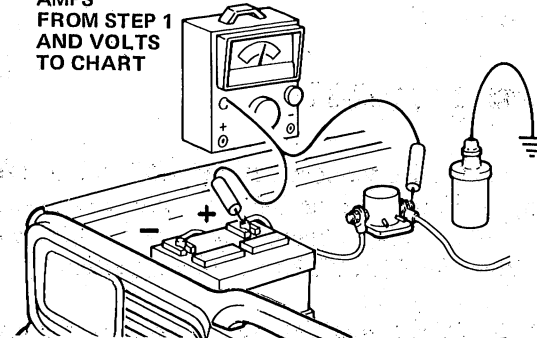

MAXIMUM VOLTAGE DROP BY FULL LOAD AMPERAGE				
AMPS	150-210	215-295	300-420	425-500
VOLTS	0.3 V	0.5 V	0.6 V	0.9 V

3

OK

VOLTAGE AT OR BELOW MAXIMUM



REPAIR SOLENOID-TO-STARTER MOTOR CABLE

5

~~OK~~

VOLTAGE ABOVE MAXIMUM



REPAIR ENGINE-TO-BATTERY CABLE

4

VOLTAGE DROP TEST
(NOTE TEST POINTS IN ILLUSTRATION)

- GROUND COIL WIRE
- CONNECT VOLTMETER
- ENGAGE STARTER MOTOR
- OBSERVE VOLTMETER
- COMPARE AMPS FROM STEP 1 AND VOLTS TO CHART

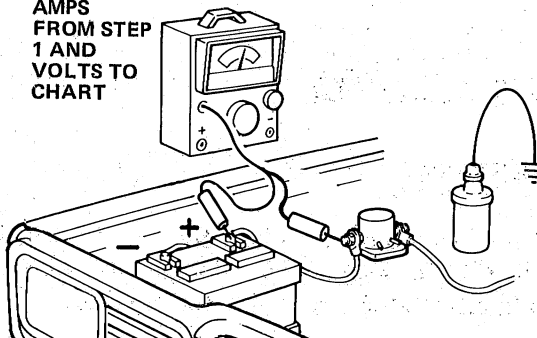

MAXIMUM VOLTAGE DROP BY FULL LOAD AMPERAGE				
AMPS	150-210	215-295	300-420	425-600
VOLTS	0.2V	0.3V	0.4V	0.5V

4

OK

VOLTAGE AT OR BELOW MAXIMUM



REPAIR SOLENOID

5

~~OK~~

VOLTAGE ABOVE MAXIMUM



REPAIR BATTERY-TO-SOLENOID CABLE

5

VOLTAGE DROP TEST
(NOTE TEST POINTS IN ILLUSTRATION)

- GROUND COIL WIRE
- CONNECT VOLTMETER
- ENGAGE STARTER MOTOR
- OBSERVE VOLTMETER
- COMPARE AMPS FROM STEP 1 AND VOLTS TO CHART

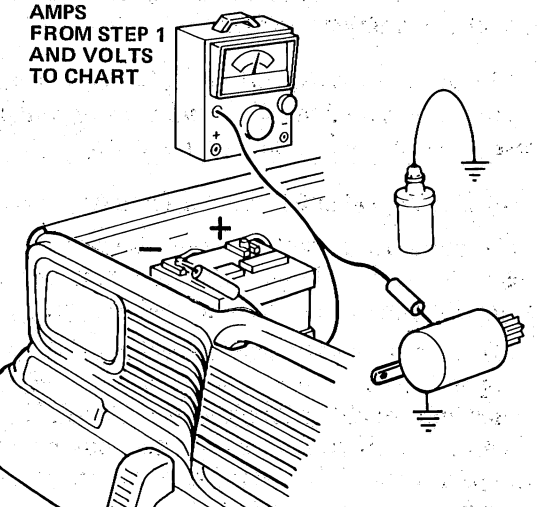

MAXIMUM VOLTAGE DROP BY FULL LOAD AMPERAGE				
AMPS	150-210	215-295	300-420	425-600
VOLTS	0.2V	0.3V	0.4V	0.5V

5

OK

VOLTAGE AT OR BELOW MAXIMUM

- REPAIRS TO SOLENOID OR CABLES PERFORMED IN A PREVIOUS STEP
- REPAIRS TO SOLENOID OR CABLES NOT REQUIRED IN A PREVIOUS STEP



REPAIR STARTER MOTOR

1

~~OK~~

VOLTAGE ABOVE MAXIMUM



REPAIR ENGINE-TO-BATTERY CABLE

1

(2) Disconnect and ground ignition coil secondary wire.

(3) Connect remote control starting switch between battery positive terminal and S-terminal on starter solenoid.

NOTE: Do not consider the initial voltage at the beginning of engine cranking. A very hot or very cold engine may cause a current of 400 to 600 amperes for the first few revolutions. Note the voltage after the starter motor has obtained its maximum rpm.

CAUTION: Do not operate for more than 15 seconds.

(4) Connect battery-alternator-starter motor tester leads as depicted in figure 1F-14. Operate remote control starting switch and note voltage indicated on voltmeter while starter motor is rotating engine.

(5) Release remote control starting switch.

(6) Turn load control knob toward INCREASE (clockwise) until voltmeter indication matches that obtained when starter motor was rotating engine.

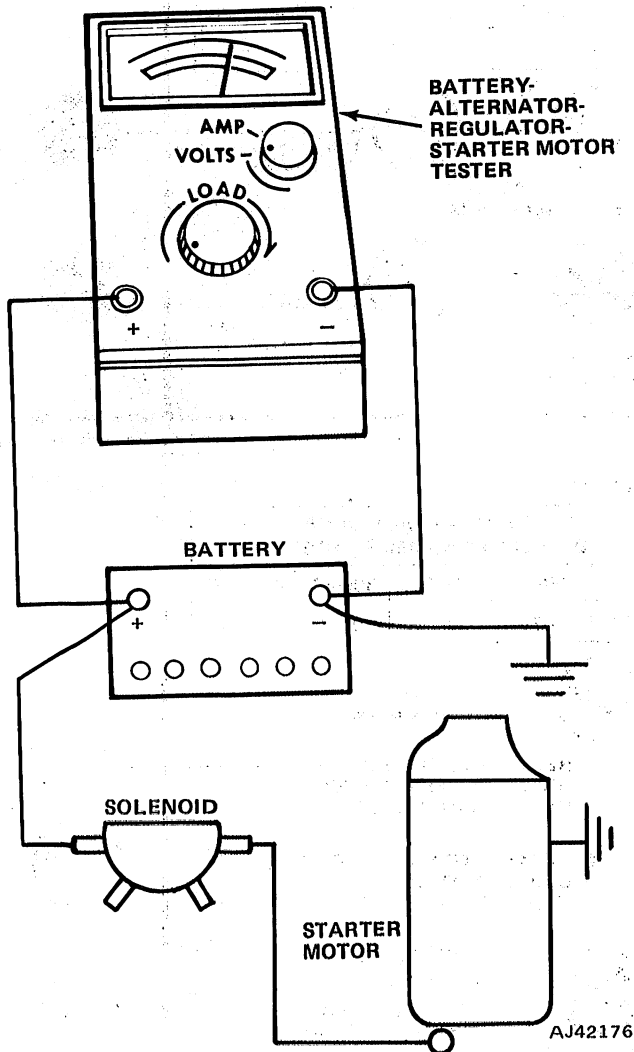

Fig. 1F-14 Starter Motor Full-Load Current Test

(7) Switch to AMP position and note current indicated on ammeter scale. This is current being used by starter motor under full-load conditions. If current is not within 150 to 180 amperes for six-cylinder engines or 160 to 210 amperes for eight-cylinder engines at room temperature, remove starter motor from engine for bench testing.

Neutral Safety Switch Test

Remove wire connector from switch and test for continuity between center terminal pin and transmission case. Continuity should exist only when automatic transmission is in Park or Neutral position.

NOTE: Probe-type tips are required on ohmmeter test leads. If not available, push cotter pins into switch connector to provide contacts for alligator jaw-type test lead terminals.

NOTE: Check linkage adjustment before replacing switch.

OFF-VEHICLE TESTING

No-Load Test

The starter motor no-load test results will indicate faults such as open or shorted windings, worn bushings (rubbing armature) or bent armature shaft.

NOTE: The tester load control knob must be in the DECREASE (extreme counterclockwise) position.

(1) Operate starter motor with test equipment connected as diagramed in figure 1F-15. Note voltage indication.

(2) Determine exact starter motor rpm using mechanical tachometer (not shown).

NOTE: To use a mechanical tachometer, remove the seal from the end of the drive end housing and clean the grease from the end of the armature shaft.

(3) Disconnect starter motor from battery.

(4) Turn load control knob toward INCREASE (clockwise) until voltage indication matches that obtained with starter motor connected to battery.

(5) Switch to AMP position and note current. If less than specification, starter motor has high electrical resistance and should be repaired or replaced. If current is more than specification and starter motor rpm is less than specification, disassemble, clean, inspect and test starter motor as outlined in following paragraphs.

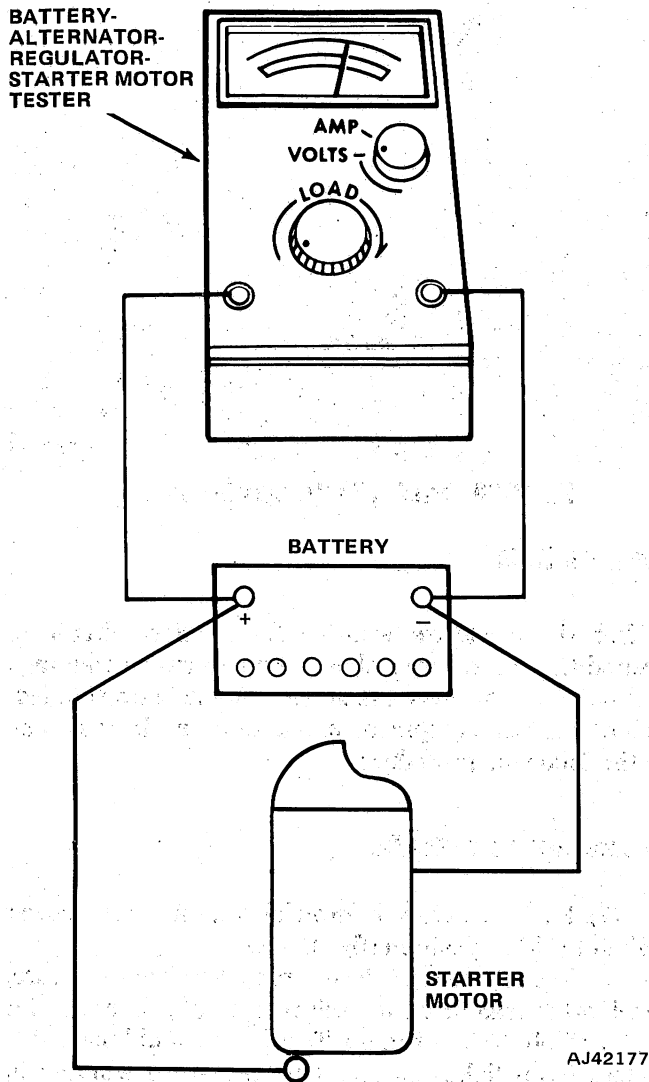

Fig. 1F-15 Starter Motor No-Load Test

Hold-In Coil Winding Resistance Test

The result of this test will determine the resistance of the hold-in winding.

(1) Insert piece of paper between contact points to serve as insulator (fig. 1F-16).

(2) Use ohmmeter to measure resistance between terminal and starter frame.

Resistance should be between 2.0 and 3.5 ohms. If resistance is not within specification, replace field winding assembly.

Solenoid Contact Points Connection Test

The result of this test will determine the quality of the solder joint at the contacts. Use an ohmmeter to measure the resistance through solder joint (fig. 1F-17). If the resistance is more than zero ohms, solder joint has excessive resistance. Repair by heating joint with 600 watt soldering iron.

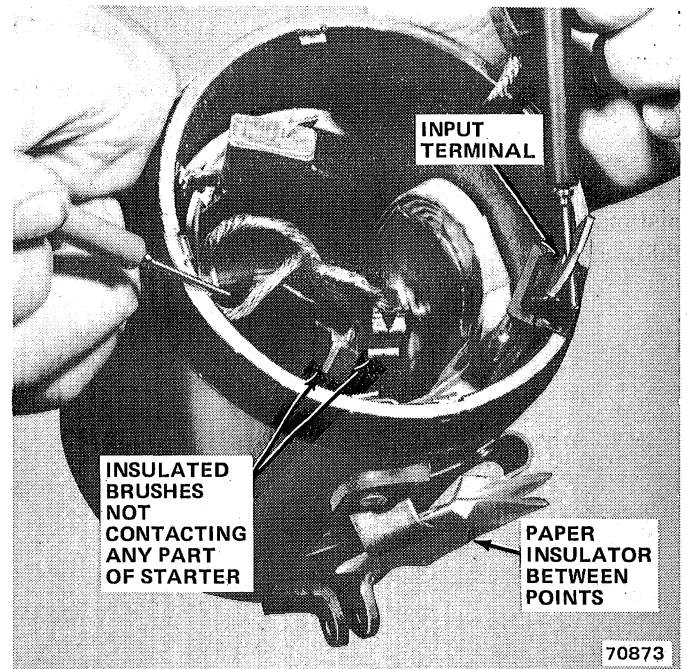

Fig. 1F-16 Hold-In Coil Winding Resistance Test



Fig. 1F-17 Solenoid Contact Points Connection Test

Insulated Brush Connection Test

The result of this test will determine the quality of the solder joint between the insulated brush braided wire and the field windings. Use an ohmmeter to test the resistance through solder joint by touching probes to brush and to copper bus bar (fig. 1F-18). If resistance is more than zero ohms, solder joint has excessive resistance. Repair by heating joint with 600 watt soldering iron.

Terminal-to-Brush Continuity Test

The result of this test will determine the condition of all field winding solder joints.

(1) Insert piece of paper between contact points to serve as insulator (fig. 1F-19).

(2) Touch ohmmeter probes to terminal and to insulated brush.

If resistance is more than zero ohms, test all solder joints to determine which one(s) has/have excessive resistance. Repair faulty solder joint(s) by heating with a 600 watt soldering iron.

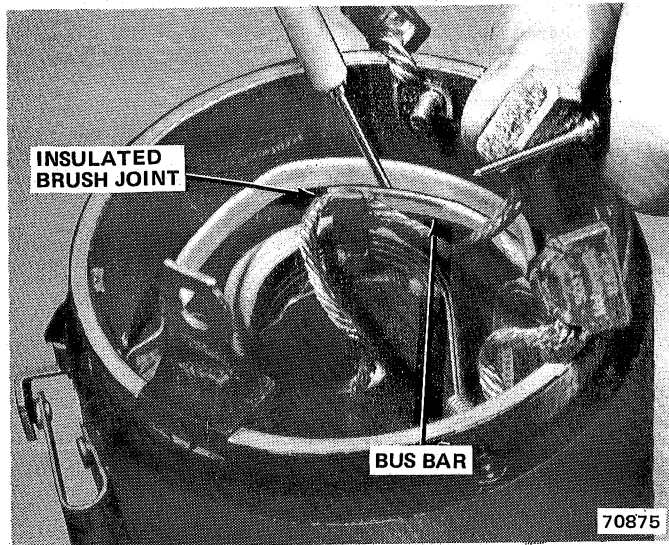

Fig. 1F-18 Insulated Brush Connection Test

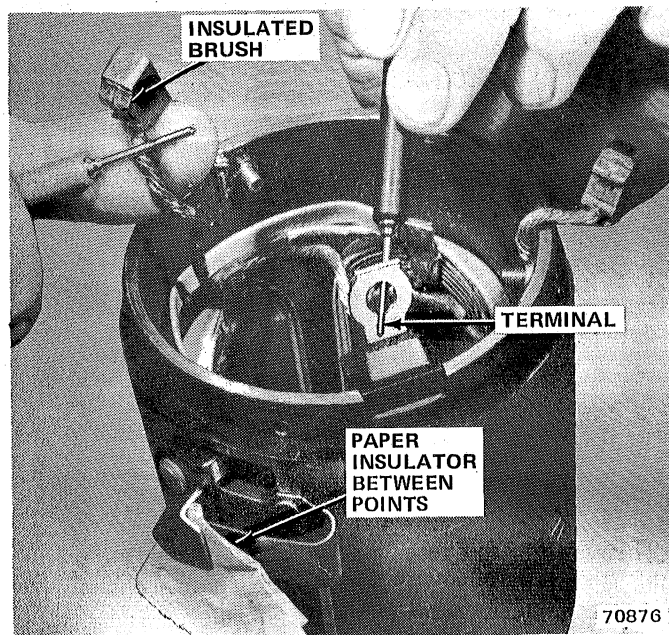

Fig. 1F-19 Terminal-To-Brush Continuity Test

Terminal Bracket Insulation Test

The result of this test will determine if the terminal bracket is properly insulated from the end cap. Use an ohmmeter to test continuity between the bracket and cap (Fig. 1F-20). If the resistance is not infinite, the insulator is faulty. Repair by replacing the end cap.

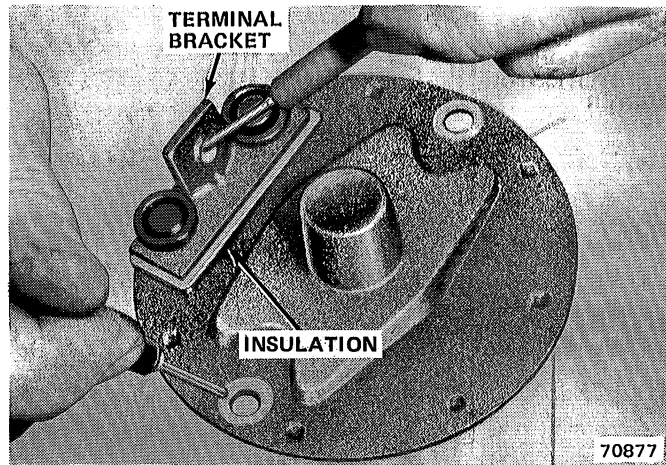

Fig. 1F-20 Terminal Bracket Insulation Test

Armature Tests

Test the armature winding for a short circuit to ground (armature core), short circuit between windings and balance whenever the starter motor is overhauled. Follow the test equipment manufacturer's instructions or the following procedure.

Grounded Armature Winding Test

(1) Place armature in growler jaws and turn power switch to TEST position (fig. 1F-21).

(2) Touch one test lead probe to armature core, touch other lead probe to each commutator bar one at a time and observe test lamp. Test lamp should not light. If test lamp lights on any bar, armature winding is shorted to armature core and armature must be replaced.

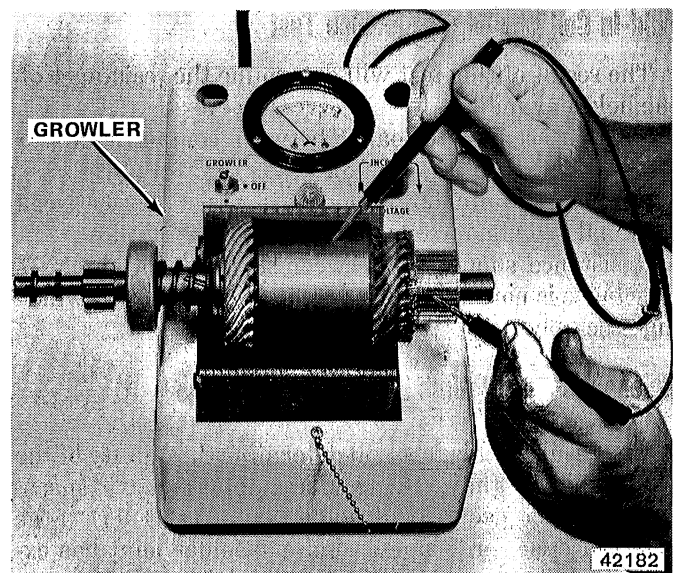

Fig. 1F-21 Grounded Armature Winding Test

Armature Winding Internal Short Test

CAUTION: Never operate the growler in the growler test position without an armature in the jaws.

(1) Place armature in growler jaws and turn power switch to GROWLER position (fig. 1F-22).

(2) Hold steel blade parallel to and touching armature core. Slowly rotate armature one or more revolutions in growler jaws. If steel blade vibrates at any area of core, winding is shorted at this area and armature must be replaced.

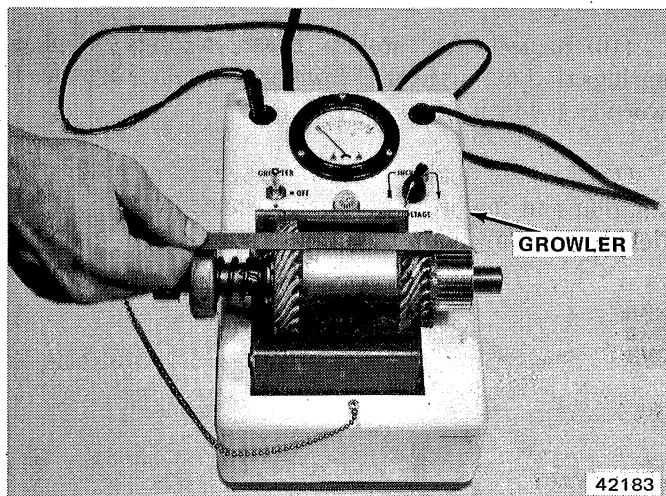

Fig. 1F-22 Armature Winding Internal Short Test

Armature Balance Test

(1) Place armature in growler jaws and turn power switch to GROWLER position (fig. 1F-23).

(2) Place contact fingers of meter test cable across adjacent commutator bars at side of commutator.

(3) Adjust voltage control until pointer indicates highest voltage on scale.

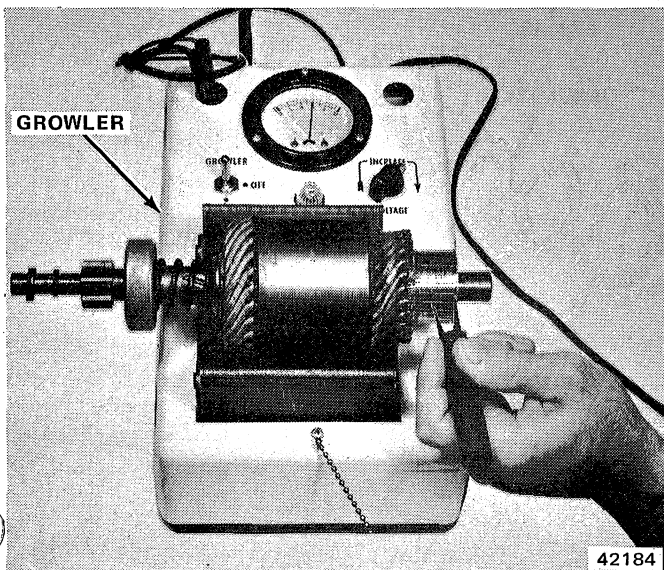

Fig. 1F-23 Armature Balance Test

(4) Test each commutator bar with adjacent bar until all bars have been tested. Zero voltage indicates short circuit between commutator bars.

STARTER MOTOR REPLACEMENT

Removal

- (1) Disconnect cable from starter motor terminal.
- (2) Remove attaching screws and remove starter motor from flywheel (drive plate) housing.

Installation

- (1) Position starter motor on flywheel (drive plate) housing.

NOTE: Ensure mounting surfaces are free of burrs and debris.

- (2) Install mounting screws and tighten with 18 foot-pounds (24 N•m) torque.

- (3) Clean terminal bracket on starter motor and terminal end of cable.

- (4) Position cable on terminal bracket. Install screw and tighten with 55 inch-pounds (6 N•m) torque.

NOTE: Initial torque may exceed this specification if the end plate is new. The terminal screw cuts threads in the terminal during installation.

STARTER MOTOR OVERHAUL

Refer to figure 1F-24 for parts identification.

Disassembly

- (1) Remove drive yoke cover and screw.
- (2) Remove through-bolts and remove brush end plate.
- (3) Remove brush springs. Pull brushes from brush holder. Remove brush holder from frame.
- (4) Remove drive end housing and drive yoke return spring.
- (5) Remove pivot pin and starter drive yoke.
- (6) Remove drive assembly and armature.

Cleaning and Inspection

- (1) Use brush or air to clean starter frame, field windings, armature, drive assembly and drive end housing.
- (2) Wash all other parts in solvent and dry.

NOTE: Do not wash clutch or drive assembly.

- (3) Inspect armature windings for broken or burned insulation and poor connections.

- (4) Inspect armature windings for open and short circuits as outlined in Armature Tests.

(5) Clean dirty commutator with commutator paper. **Never use emery cloth to clean commutator.**

(6) If armature commutator is worn, out-of-round (0.005 inch or more), or has insulation protruding from between contacts, turn down on lathe.

(7) Inspect armature shaft and bushings for scoring and excessive wear.

(8) Inspect drive assembly pinion gear for damage. An engine that has repeated starter motor pinion gear failures should be inspected for:

- correct ring gear clearance in relation to the starter motor mounting surface as illustrated in figure 1F-25.
- missing or wrong parts or misaligned flywheel (drive plate) housing.
- wobbling ring gear. Maximum allowable runout is 0.030 inch (0.76 mm). Inspect for broken welds or broken flex plate.
- foreign object such as converter balance weight in drive plate housing.

NOTE: *Inspect the entire circumference of the ring gear for damage when the teeth of the drive assembly pinion gear are damaged. A normal wear pattern will be found in three places on 6-cylinder engine ring gears and four places on 8-cylinder engine ring gears. The normal wear pattern extends approximately two inches along the circumference of the ring gear.*

(9) Inspect drive assembly overrunning clutch by grasping and rotating pinion gear. Gear should rotate freely in one direction and lock in opposite direction.

(10) Inspect for broken brush springs. Replace springs that are discolored from heat. Replace brushes if worn to 1/4 inch (6.4 mm) in length.

(11) Inspect field windings for burned or broken insulation and for broken or loose connections. Examine field brush connections and wire insulation.

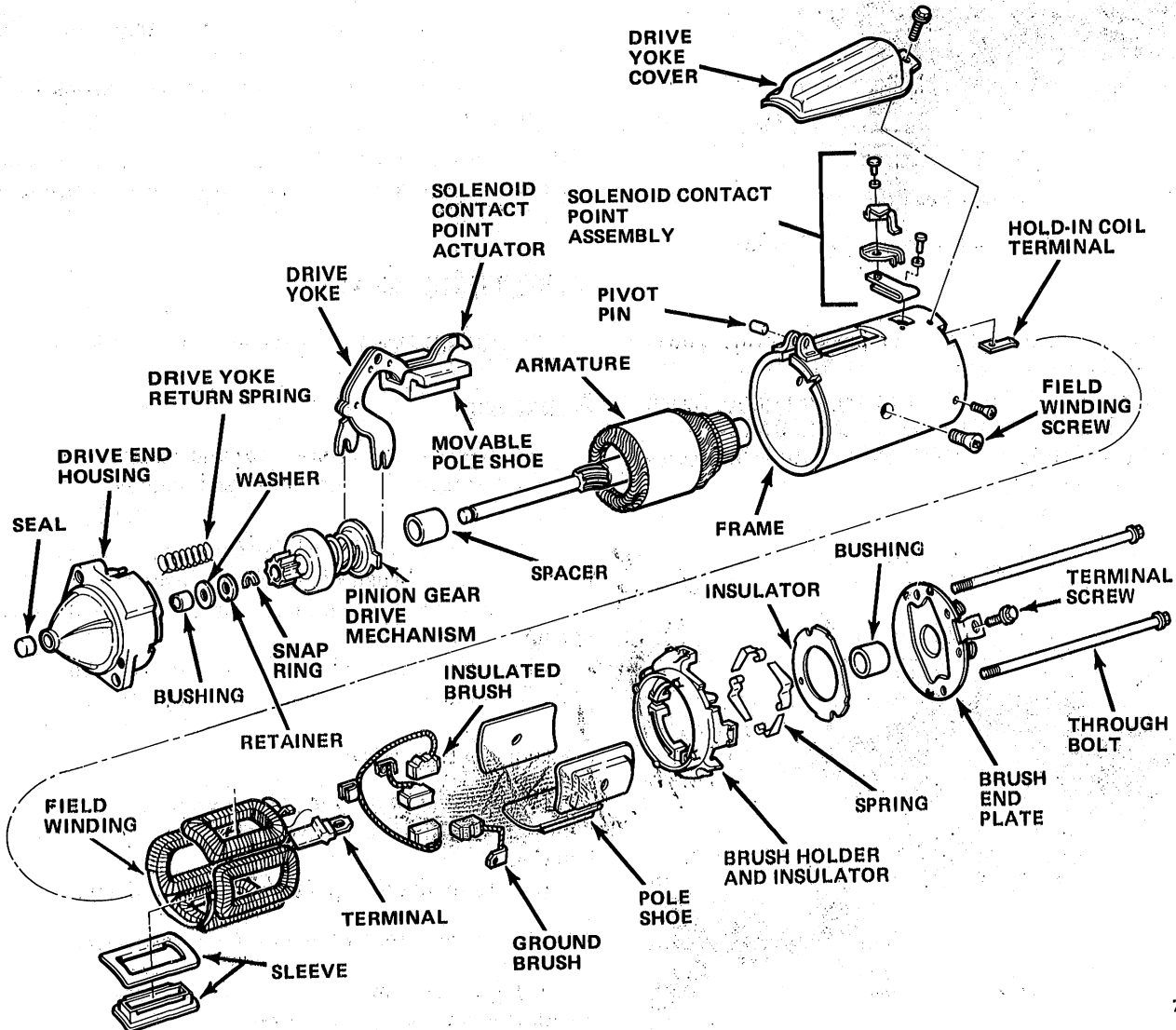
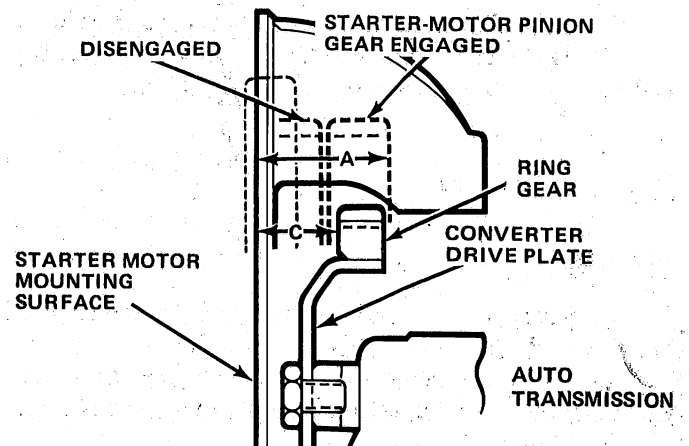
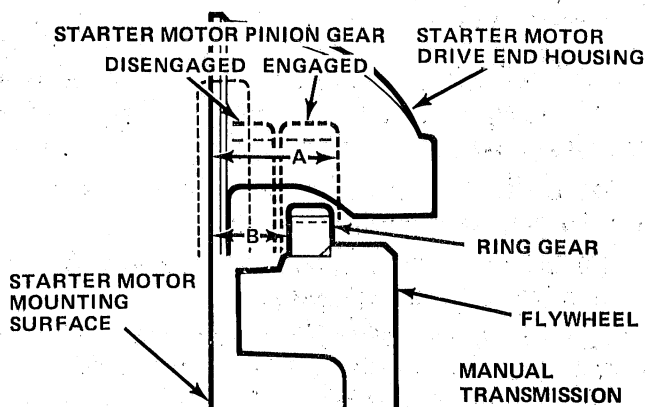

Fig. 1F-24 Parts Identification



ENGINE	FLYWHEEL (INCHES)			
	A		B	
6-CYLINDER	1.2465	1 - 1/4	0.8365	27/32
	TO 1.2060	TO 1 - 13/64	TO 0.7660	TO 49/64
8-CYLINDER	1.2465	1 - 1/4	0.8365	27/32
	TO 1.2035	TO 1 - 13/64	TO 0.7635	TO 49/64

60137

ENGINE	DRIVE PLATE (INCHES)			
	A		C	
6-CYLINDER	1.2465	1 - 1/4	0.8305	53/64
	TO 1.2060	TO 1 - 13/64	TO 0.7700	TO 49/64
8-CYLINDER	1.2465	1 - 1/4	0.8305	53/64
	TO 1.2035	TO 1 - 13/64	TO 0.7675	TO 49/64

60138

Fig. 1F-25 Flywheel/Drive Plate-To-Ring Gear Clearance

Field Winding Replacement

Remove armature and brush holder before proceeding with this procedure.

(1) Remove field winding screws using arbor press and Starter Pole Screw Wrench J-22516. Remove pole shoes.

(2) Cut field winding strap as close as possible to solenoid point contact-to-field winding joint.

CAUTION: Do not cut solenoid point contact.

(3) Cut hold-in winding wire at terminal strip.

(4) Straighten tabs of pull-down winding sleeve. Remove sleeve and flange.

(5) Remove field winding assembly from frame.

(6) Clean and tin surfaces of contact tab and field winding strap that are to be soldered.

(7) Install replacement field winding assembly in frame using original pole shoes and screws. Apply drop of Loctite or equivalent to screw threads. Tighten screws using arbor press and Starter Pole Screw Wrench J-22516.

(8) Install pull-down winding sleeve and flange. Have helper hold winding and sleeve assembly against frame while bending retaining tabs.

(9) Wrap hold-in winding wire around terminal strip and solder. Cut off excess wire.

(10) Solder field winding strap to contact strap. Use 600 watt soldering iron and rosin-core solder.

Solenoid Contact Point Assembly Replacement

Remove armature and brush holder before proceeding with this procedure.

(1) Cut upper contact as close as possible to contact point-to-field winding joint.

CAUTION: Do not cut field winding strap.

(2) Unsolder hold-in winding wire from terminal strip.

(3) Remove field winding screws using arbor press and Tool J-22516. Remove pole shoes.

(4) Cut rivets inside frame with chisel. Remove contact point assembly.

NOTE: Ensure holes for second rivet are aligned before upsetting copper rivet.

(5) Position replacement lower (movable) contact point on frame (fig. 1F-26). Position hold-in winding terminal strip inside frame. Insert copper rivet through contact, frame and terminal. Upset rivet.

NOTE: Ensure upper contact point is positioned on shoulder of plastic insulator before upsetting rivet.

(6) Install plastic insulator, upper contact point and fiber washer to remaining hole in frame. Insert aluminum rivet and upset.

(7) Install field winding assembly, pole shoes and screws. Apply a drop of Loctite or equivalent to each screw.

- (8) Solder hold-in winding wire to terminal strip.
- (9) Solder field winding strap to upper contact. Use 600 watt soldering iron and rosin-core solder.

Bushing Replacement

Drive End Bushing

- (1) Support drive end housing and remove original bushing and seal.
- (2) Install replacement bushing using armature and pinion as bushing driver. **Do not** install drive end housing seal at this time.

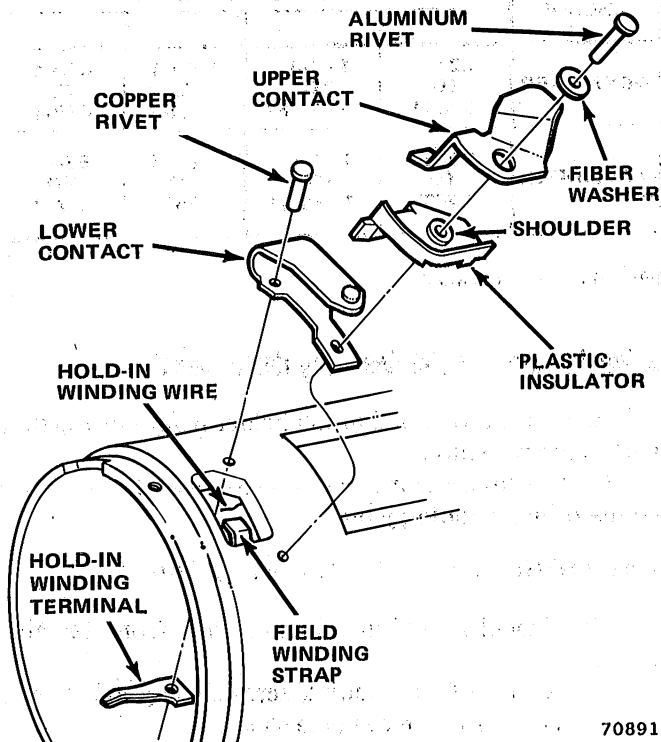

Fig. 1F-26 Solenoid Contact Points Replacement

70891

Commutator End Bushing

- (1) Carefully remove original bushing with chisel.
- (2) Drive replacement bushing into end plate until seated, using suitable socket or bushing driver.

Drive Assembly Replacement

- (1) Pry stop ring off and remove starter motor drive assembly from armature shaft.
- (2) Apply grease to armature shaft and end bushings. Service replacement drive assembly is prelubricated.
- (3) Apply thin coating of Lubriplate or equivalent on armature shaft splines.
- (4) When installing drive assembly, examine snap ring for tight fit on shaft. Slide drive assembly over shaft and install stop ring and original retainer.

Assembly

- (1) Insert armature into frame. Install drive yoke and pivot pin. Drive yoke must engage lugs on drive assembly.
- (2) Insert drive yoke return spring into recess in drive housing. Join housing to frame.
- (3) Install brush holder. Ensure depression in holder aligns with rubber boot on terminal.
- (4) Insert brushes into brush holder. Refer to figure 1F-27 for proper wire routing. Install brush springs.
- (5) Install end plate. Align hole in terminal with hole in terminal bracket.
- (6) Install through-bolts.

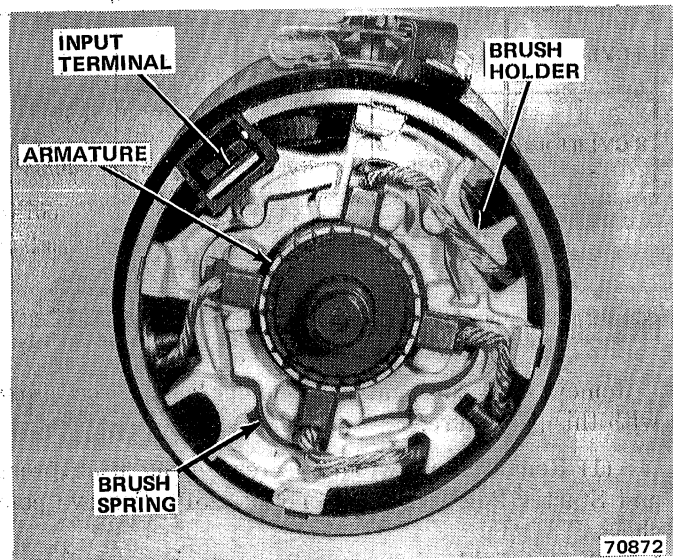

70872

Fig. 1F-27 Brush Wire Routing

- (7) Depress movable pole shoe and adjust contact point clearance by bending upper contact as required. Refer to Specifications.
- (8) Install drive yoke cover and screw.

NEUTRAL SAFETY SWITCH REPLACEMENT

- (1) Disconnect wiring connector and remove switch from transmission. Allow fluid to drain into container.
- (2) Move selector lever to Park and Neutral positions. Inspect switch operating lever fingers to ensure they are properly centered in switch opening.

NOTE: Check linkage adjustment before replacing switch.

- (3) Install switch and seal on transmission case. Tighten switch with 24 foot-pounds (6 N•m) torque.
- (4) Test switch continuity.
- (5) Correct transmission fluid level as required.

SPECIFICATIONS

Six- and Eight-Cylinder Engine Starter Motor Specifications

Item	Specifications
Frame Diameter	4.5 inches (114.3 mm)
Brush Length	0.5 inches (12.7 mm)
Wear Limit	0.25 inches (6.35 mm)
No Load Test (Free Speed)	
Volts	12
Amps	67
Min. RPM	7380
Max. RPM	9356
Contact Point Clearance	0.100 - 0.020 inch (2.5 - 0.5 mm) (0.060 preferred) (1.5 mm)

80253

Torque Specifications

Service Set-To Torques should be used when assembling components. Service In-Use Recheck Torques should be used for checking a pre-tightened item.

	USA (ft-lbs)		Metric (N ² m)	
	Service Set-To Torque	Service In-Use Recheck Torque	Service Set-To Torque	Service In-Use Recheck Torque
Neutral Safety Switch-to-Transmission Case	17	14-21	23	19-28
Starter Motor-to-Flywheel/Converter Housing	18	13-25	24	18-34
Starter Terminal Screw	55 in-lbs	40-70 in-lbs	6	4.5-9

All Torque Values given in foot-pounds and newton meters with dry fits unless otherwise specified.

81184

Tools

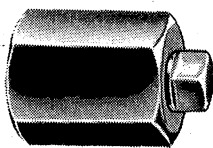

**J-22516
STARTER POLE
SCREW WRENCH**



**AMA 21-317
CIRCUIT TESTER**

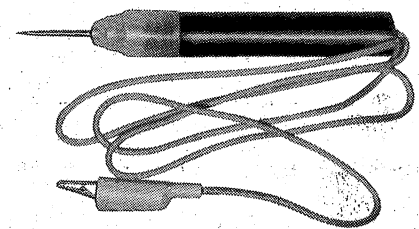

**J-21008
CONTINUITY
TEST LAMP**

70112

NOTES

[The page contains several lines of extremely faint, illegible text, likely bleed-through from the reverse side of the paper. The text is too light to transcribe accurately.]